

# Cleco®

## Pneumatic Assembly Tools



**HERMES**   
THE TOOL COMPANY

**Kompania Narzędziowa "HERMES" Sp. z o.o.**  
ul. Sarni Stok 73 a, 43-300 Bielsko-Biała, Polska; tel: +48 33 821 41 90-91  
e-mail: [biuro@hermestools.eu](mailto:biuro@hermestools.eu) [www.hermestools.eu](http://www.hermestools.eu)





<b>Screwdrivers</b> .....	<b>2-14</b>
Introduction .....	2-5
Clutch Selection Guide .....	3
Inline – Clutch .....	6-7
Pistol – Clutch .....	8-10
Pistol – Stall .....	11
Accessories .....	12-13
Nomenclature .....	14
<b>Angle Nutrunners</b> .....	<b>15-23</b>
Introduction .....	15-17
Angle Nutrunners – Clutch .....	18-21
Angle Nutrunners – Stall .....	22-23
<b>Reaction Bar &amp; Swingbar Nutrunners</b>	<b>24-27</b>
Introduction .....	24-25
Inline & Pistol Tools .....	26-27
<b>Specialty Tools</b> .....	<b>28-35</b>
Flush Socket Nutrunners .....	28-29
Crowfoot Nutrunners .....	30-31
Hold & Drive Nutrunners .....	32-33
Tube Nut Wrenches .....	34-35
<b>Nutrunner Accessories</b> .....	<b>36-39</b>
General .....	36
Torque Verifier .....	37-39
<b>Ratchet Wrenches</b> .....	<b>40-47</b>
Introduction .....	40-41
Tools & Accessories .....	42-47
<b>Pulse Nutrunners</b> .....	<b>48-52</b>
Introduction .....	48-49
Tools & Accessories .....	50-53
<b>Impact Wrenches</b> .....	<b>54-57</b>
Introduction .....	54-55
Impact Wrenches .....	56-57
<b>General Accessories</b> .....	<b>58-67</b>
Introduction .....	58
Balancers .....	59
Arms & Accessories .....	60-62
Apex Fastener Tools .....	64-67
<b>General Information</b> .....	<b>68-76</b>
Conversion Tables .....	68
Sales & Service Centers .....	70
Warranty, Lubrication, Safety .....	72
Model Number Index .....	74-76

## Cleco®

### A tradition of quality is built into every screwdriver.

Cleco screwdrivers have long been recognized as the assembly tool standard against which all other brands are measured. With over 100 years of precision manufacturing experience built into each tool, Cleco screwdrivers provide users the ultimate in light and medium duty assembly tool performance.

Cleco's long standing tradition of service to the customer has led us to develop an extensive line of screwdrivers with configurations to suit a broad range of applications. Options including multiple reversing methods, different clutch styles, numerous handle alternatives, and a wide variety of accessories provide the building blocks for tool configurations designed to meet our customers' unique assembly application requirements.

The Cleco 2 series of inline Clecomatic screwdrivers offer dependable repetitive torque accuracy from .5 to 8 in.-lbs., ideal for miniature assemblies often found in extra light-duty electronics assembly using #0 to #5 screws.

In the light to medium duty assembly tool market, the ergonomically designed Cleco 19 series screwdrivers, with a torque range of 0.6 to 130 in.-lbs., are the ultimate tools for an infinite range of applications including electronics, automotive, aerospace, appliance and general assembly.

With a torque range of 15 to 180 in.-lbs (1.7 to

### 60 MONTH WARRANTY

#### Cleco® 19 & 8 Series Clecomatic® Screwdrivers

Apex Tool Group warrants the 19 and 8 series Clecomatic screwdrivers and parts to be free from defects in workmanship and material of the life of the tool. The clutch assemblies are warranted for SIXTY MONTHS against failure or wear causing malfunction.

Apex Tool Group's obligation under this warranty is to repair or replace, without charge to the original purchaser, any part which does not meet the warranty outlined above during the active commercial production of this tool. This tool is to be returned to the factory with carrying charges prepaid.

This warranty shall not apply to any product that has been fixture mounted or subjected to misuse, negligence or accident; or in which parts not made or supplied by Apex Tool Group shall have been used; or which shall have been altered or repaired by other than Apex Tool Group personnel in a manner which in the determination of Apex Tool Group shall have affected its operation.

THIS WARRANTY CONSTITUTES THE ENTIRE OBLIGATION OF THE COMPANY RELATING TO THE SALE AND USE OF SUCH PRODUCT AND ITS MAXIMUM LIABILITY IS LIMITED TO THE PURCHASE PRICE OF SUCH PRODUCT. IN NO EVENT SHALL THE COMPANY BE LIABLE FOR CONSEQUENTIAL, INDIRECT, INCIDENTAL OR SPECIAL DAMAGES OF ANY NATURE ARISING FROM THE SALE OF USE OF SUCH PRODUCT.

20Nm), the 8 & 88 series Cleco screwdrivers cover the gamut of medium duty assembly applications ranging from lawn and garden equipment to small recreational vehicles, and even aerospace.

Capable of running down fasteners as large as 5/16 (M6), the Cleco 35 series screwdrivers are the true workhorses of the medium to heavy-duty screw assembly market.





**Choose the right tool to match your application.**



**New Clecomatic® Clutch**

**Clecomatic® Clutch**

When tightening a fastener, torque is transmitted through the Clecomatic clutch to the fastener until the clutch can no longer transmit the increasing torque. The clutch then “slips”, which allows an internal mechanism to seal off air to the air motor, shutting off the tool at the user-adjusted preset torque level. This type of torque control allows maximum RPM from the tool for increased productivity. Since the tool doesn’t dwell on the fastener as with a stall tool, tool wear and fatigue to the operator is reduced. The life of a Clecomatic tool is up to five times longer than that of a lever-operated, ratcheting clutch screwdriver.

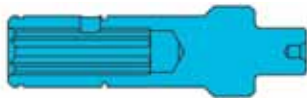

**Stall Type**

**Stall Type**

The stall tool doesn’t use a clutch but rather the output spindle is coupled to the last stage of gearing. Torque output from a stall tool may be controlled within fairly reasonable limits with an air pressure regulator. Stall type tools are also trigger activated.

**CLUTCH SELECTION GUIDE FOR COMMON FASTENING APPLICATIONS**

CLUTCH TYPE	APPLICATION	STANDARD BOLT & NUT	SHEET METAL SCREW	STANDARD BOLT & NUT	SELF-TAPPING SCREW	SELF-LOCKING NUT
Clecomatic®		<b>EXCELLENT</b>	<b>EXCELLENT</b>	<b>EXCELLENT</b>	<b>EXCELLENT</b> Where seating torque exceeds tapping torque	<b>EXCELLENT</b>
Stall Drive		<b>FAIR</b> Under certain conditions	<b>GOOD</b> Under certain conditions	<b>FAIR</b> Under certain conditions	<b>FAIR</b> Under certain conditions	<b>FAIR</b>

# Accuracy. Durability.

## Built by your expertise and our experience

Your productivity is our greatest influence. The development of the Cleco 19 Series is driven by experts—you, the very people that have depended on Cleco assembly products for over a century.

## Whatever your application, consider it done

We set out to design the most accurate, longest-lasting, most user-friendly screwdriver family on the market. Our widespread configurations and applications ensure that you will find the ideal screwdriver or nutrunner.



## Designed for the most demanding jobs

Continuously improving end-product quality is evermore critical. The Cleco 19 Series is engineered for the most demanding fastening applications where accuracy, repeatability, and durability are held to the strictest standard. Imagine what the Cleco 19 Series can do for you.

## Adding value to your business

With a new powertrain design, the Cleco 19 Series tools have reached a new milestone in performance and accuracy. This, combined with legendary Cleco reliability, means you will have the sustained power to get it right the first time, every time.

## Designed with the operator in mind

A soft-touch grip is integrated into the new handle design to provide superior protection from temperature, chemicals, vibration, and slip. What's more, Cleco 19 Series pistol tools offer two interchangeable handle sizes to bring comfort to a wider array of operators. These features, plus reduced weight and a balanced design, will raise productivity, tool flexibility, and reduce maintenance costs.



# Quality. Productivity.

Completely re-engineered **Clecomatic®** clutch delivers **best-in-class accuracy**, exceeding a Cm of 2.0 with a tolerance of  $\pm 10\%$ .

New design and advanced materials yield up to **19% weight reduction** based on configuration, at no loss of balance or durability.

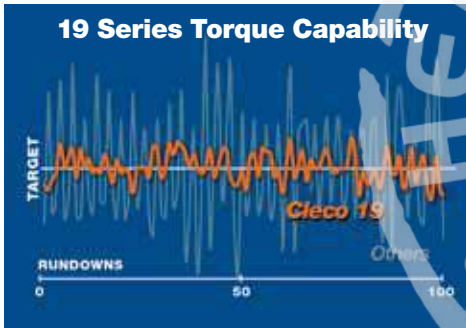
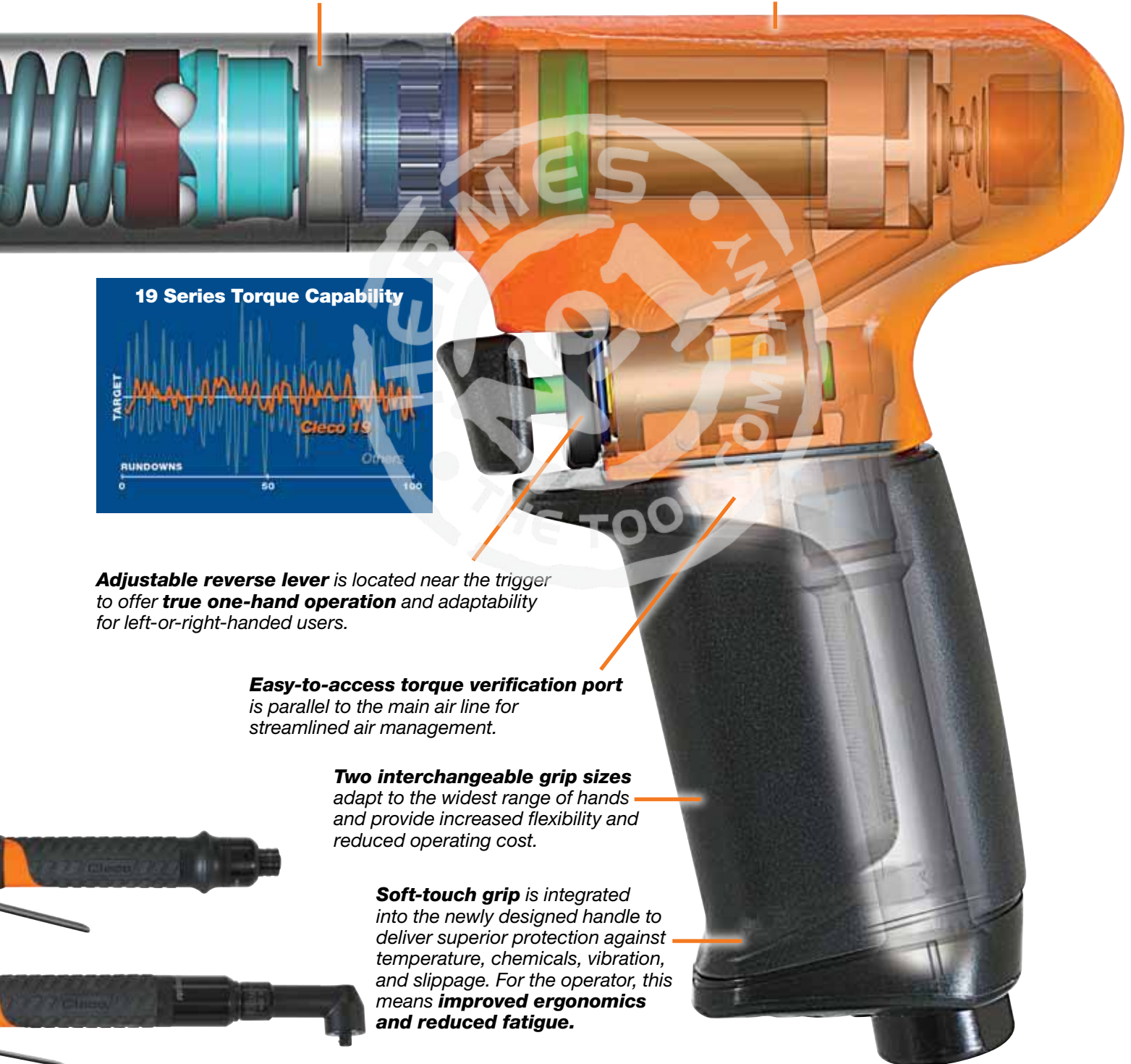

**Adjustable reverse lever** is located near the trigger to offer **true one-hand operation** and adaptability for left-or-right-handed users.

**Easy-to-access torque verification port** is parallel to the main air line for streamlined air management.

**Two interchangeable grip sizes** adapt to the widest range of hands and provide increased flexibility and reduced operating cost.

**Soft-touch grip** is integrated into the newly designed handle to deliver superior protection against temperature, chemicals, vibration, and slippage. For the operator, this means **improved ergonomics and reduced fatigue**.

# Inline Screwdrivers

2, 19, 8, 88, 35 Series Clecomatic Clutch

## Cleco®

### 2 Series

Torque Range: .06 - .9 Nm 0.5 - 8 In. Lbs.

- Push-to-start
- Push button reverse
- External torque adjustment
- 1/4" quick change chuck

### 19 Series

Torque Range: 0.6 - 14.7 Nm 5 - 130 In. Lbs.

- Push-to-start and Push & Lever start
- External torque adjustment
- Bit & Finder & 1/4" quick change chuck

### 8 Series

Torque Range: 1.7 - 8.5 Nm 15.0 - 75 In. Lbs.

- Push button reverse and non-reversible
- Push-to-start and Push & Lever start
- Bit & Finder and Quick change

### 88 Series

Torque Range: 1.7 - 19 Nm 15 - 170 In. Lbs.

- Push button reverse and non-reversible
- Push-to-start and Push & Lever start
- Quick change & 3/8" square drive

### 35 Series

Torque Range: 1.7 - 20 Nm 15 - 180 In. Lbs.

- Quick change and square drive
- Short stroke button reverse
- External torque adjustment (Quick change models)



Model Number		Torque Range				Free Speed	Length*		Weight		Air Consumption		
Bit & Finder*	1/4" Quick Change	Tool Range		With Std. Spring			in.	mm	lbs.	kg	Air Inlet NPT	Min. Hose I.D.	SCFM
		in.-lbs.	Nm	in.-lbs.	Nm	RPM							
<b>Push-to-Start - Push Button Reverse</b>													
	2RSA-10B			0.5 - 8	.06 - 0.9	1000	7.6	194	0.5	0.20	1/8"	3/16"	6
	2RSA-10SB**			0.5 - 8	.06 - 0.9	1000	6.4	162	0.5	0.20	1/8"	3/16"	6
	19BPA02Q	5 - 19	0.6 - 2.1	5 - 19	0.6 - 2.1	2300	9.1	230	1.4	0.63	1/8"	3/16"	11
	19BPA03Q	5 - 26	0.6 - 2.9	5 - 19	0.6 - 2.1	1600	9.3	235	1.4	0.64	1/8"	3/16"	11
	19BPA04Q	10 - 40	1.1 - 4.5	10 - 38	1.1 - 4.3	920	9.1	230	1.3	0.61	1/8"	3/16"	11
	19BPA05Q	10 - 45	1.1 - 5.1	10 - 38	1.1 - 4.3	560	9.5	240	1.5	0.67	1/8"	3/16"	11
	19BPA06Q	10 - 45	1.1 - 5.1	10 - 38	1.1 - 4.3	220	9.5	240	1.5	0.68	1/8"	3/16"	11

**Push-to-Start - Collar Reverse**

	19SPA02B	19SPA02Q	5 - 19	0.6 - 2.1	5 - 19	0.6 - 2.1	2800	9.1	230	1.4	0.63	1/8"	3/16"	11
	19SPA03B	19SPA03Q	5 - 26	0.6 - 2.9	5 - 19	0.6 - 2.1	1900	9.3	235	1.4	0.64	1/8"	3/16"	11
	19SPA04B	19SPA04Q	10 - 40	1.1 - 4.5	10 - 38	1.1 - 4.3	1100	9.1	230	1.3	0.61	1/8"	3/16"	11
	19SPA05B	19SPA05Q	10 - 45	1.1 - 5.1	10 - 38	1.1 - 4.3	660	9.5	240	1.5	0.67	1/8"	3/16"	11
	19SPA06B	19SPA06Q	10 - 45	1.1 - 5.1	10 - 38	1.1 - 4.3	260	9.5	240	1.5	0.68	1/8"	3/16"	11

**Lever Push-to-Start - Collar Reverse**

	19SCA02B	19SCA02Q	5 - 19	0.6 - 2.1	5 - 19	0.6 - 2.1	2800	9.8	249	1.5	0.69	1/8"	3/16"	11
	19SCA03B	19SCA03Q	5 - 26	0.6 - 2.9	5 - 19	0.6 - 2.1	1900	10.0	254	1.5	0.70	1/8"	3/16"	11
	19SCA04B	19SCA04Q	10 - 40	1.1 - 4.5	10 - 38	1.1 - 4.3	1100	9.8	249	1.5	0.66	1/8"	3/16"	11
	19SCA05B	19SCA05Q	10 - 45	1.1 - 5.1	10 - 38	1.1 - 4.3	660	10.2	259	1.6	0.73	1/8"	3/16"	11
	19SCA06B	19SCA06Q	10 - 45	1.1 - 5.1	10 - 38	1.1 - 4.3	260	10.2	259	1.6	0.74	1/8"	3/16"	11

\*Add .63" (16mm) for bit & finder models

\*\* Short housing

**General:**

90 psi (620kPa) required for maximum rated torque.

**Standard Equipment:**

Operating instructions & service manual.  
Suspension bail.

All torque springs required to meet indicated torque.

Lever Push-to-Start models include kit to convert to lever only. (301409)

**Optional Equipment:**

Additional accessories: Pages 12-13  
Bits & finders: Page 12

Non-Reverse Kit: 207030

Torque Signal Kit: 301106 (lever only)

Overhose: 207019

Model Number			Torque Range		Free Speed	Length*		Weight		Air Consumption			
Bit & Finder	1/4" Hex Quick Change	3/8" Square Drive	in.-lbs.	Nm		in.	mm	lbs.	kg	Air Inlet NPT	Min. Hose I.D.	SCFM	
					RPM								
<b>Push-to-Start - Push Button Reverse</b>													
	8RSA-10	8RSA-10BQ	15 - 65	1.7 - 7.3	800	9.6	260	2.4	1.1	1/4"	1/4"	19	
		8RSA-7BQ	15 - 75	1.7 - 8.5	550	9.6	260	2.4	1.1	1/4"	1/4"	19	
		8RSA-5BQ	15 - 75	1.7 - 8.5	400	9.6	260	2.4	1.1	1/4"	1/4"	19	
		88RSA-7CQ	88RSA-7C-3	15 - 95	1.7 - 10	550	9.5	241	2.6	1.2	1/4"	1/4"	19
		88RSA-5CQ	88RSA-5C-3	15 - 160	1.7 - 18	400	9.5	241	2.6	1.2	1/4"	1/4"	19

**Push-to-Start - Non-Reversible**

		88SA-7CQ	15 - 100	1.7 - 11	650	9.1	232	2.5	1.1	1/4"	1/4"	19	
		88SA-5CQ	88SA-5C-3	15 - 170	1.7 - 19	500	9.1	232	2.5	1.1	1/4"	1/4"	19

**Push and Lever Start - Push Button Reverse**

		8RSAL-10BQ	15 - 60	1.7 - 6.8	800	11.3	302	2.9	1.3	1/4"	1/4"	19	
		88RSAL-5CQ	88RSAL-5C-3	15 - 160	1.7 - 18	400	11.1	282	3.1	1.4	1/4"	1/4"	19

**Inline - Push-to-Start - Push Button Reverse**

		35RSA-20Q	15 - 60	1.7 - 7	1250	9.6	244	2.5	1.1	1/4"	5/16"	24	
		35RSA-10Q	35RSA-10-3	15 - 110	1.7 - 12	620	10.4	264	2.8	1.2	1/4"	5/16"	24
		35RSA-7Q		15 - 160	1.7 - 18	410	10.4	264	2.8	1.2	1/4"	5/16"	24
		35RSA-5Q	35RSA-5-3	15 - 180	1.7 - 20	300	10.4	264	2.8	1.2	1/4"	5/16"	24

\*Add .63" (16mm) for bit & finder models

**General:**

90 psi (620kPa) required for maximum rated torque.

Length and weight of finder type tools includes standard length bit & finder.

Weight does not include dead handle.

**Standard Equipment:**

Operating instructions & service manual

Suspension bail

Dead handle on models above 100 in.lbs. torque cap.

All torque springs required to meet indicated torque

**Standard Equipment if Specified:**

One bit, finder, and finder spring (bit & finder models)

Grip Sleeve (202346; Push-to-Start models only)

Dead handle (861006)

**Optional Equipment:**

Additional accessories: Pages 12-13

Bits & finders: Page 12

Torque Springs: Page 13



# Pistol Grip Screwdrivers

19 Series Clecomatic Clutch

## Cleco®

### 19 Series

**Torque Range: 0.6-14.7 Nm 5.0-130 In. Lbs.**

- Class-leading accuracy and repeatability
- Adjustable reverse lever for true one-hand – left-handed or right-handed – operation
- External torque adjustment
- 1/4" hex quick change drive
- "P" and "T" style handles
- 2 interchangeable soft-touch grip sizes
- Streamlined torque signal ports
- Trigger and Push & Trigger start



**NEW!**



19TTA02Q  
"T" Handle

19PTA05Q  
"P" Handle

*The renowned Clecomatic® clutch is re-engineered to provide class-leading accuracy/repeatability and improve the already legendary durability.*

*The "T" handle is best for applications that are pre-threaded and the grip on the tool is required to simply guide the tool as the fastener is being tightened.*

*The "P" handle is best suited for thread cutting fasteners where force must be exerted against the ergonomically shaped "P" handle during the process.*



Model Number	Torque Range				Free Speed	Length		Weight		Air Consumption		
	Tool Range		With Std. Spring			in.	mm	lbs.	kg	Air Inlet NPT	Min. Hose I.D.	SCFM
1/4" Quick Change	in.-lbs.	Nm	in.-lbs.	Nm	RPM							

**Push and Trigger Start - T Handle - Clecomatic Clutch**

19TCA02Q	5 - 19	0.6 - 2.1	5 - 19	0.6 - 2.1	2800	8.0	202	1.44	0.7	1/4"	3/8"	11
19TCA03Q	5 - 26	0.6 - 2.9	5 - 19	0.6 - 2.1	1900	8.2	207	1.54	0.7	1/4"	3/8"	11
19TCA04Q	10 - 40	1.1 - 4.5	10 - 38	1.1 - 4.3	1100	8.0	202	1.54	0.7	1/4"	3/8"	11
19TCA05Q	10 - 45	1.1 - 5.1	10 - 38	1.1 - 4.3	660	8.4	212	1.54	0.7	1/4"	3/8"	11
19TCA06Q	10 - 45	1.1 - 5.1	10 - 38	1.1 - 4.3	260	8.4	212	1.54	0.7	1/4"	3/8"	11
19TCA07Q	15 - 60	1.7 - 6.8	24 - 60	2.7 - 6.8	660	8.4	212	1.54	0.7	1/4"	3/8"	11
19TCA09Q	15 - 79	1.7 - 8.9	24 - 60	2.7 - 8.9	470	9.3	235	1.73	0.8	1/4"	3/8"	11

**Trigger Start - T Handle - Clecomatic Clutch**

19TTA02Q	5 - 19	0.6 - 2.1	5 - 19	0.6 - 2.1	2800	7.9	199	1.44	0.7	1/4"	3/8"	11
19TTA03Q	5 - 26	0.6 - 2.9	5 - 19	0.6 - 2.1	1900	8.1	204	1.54	0.7	1/4"	3/8"	11
19TTA04Q	10 - 40	1.1 - 4.5	10 - 38	1.1 - 4.3	1100	7.9	199	1.54	0.7	1/4"	3/8"	11
19TTA05Q	10 - 45	1.1 - 5.1	10 - 38	1.1 - 4.3	660	8.3	210	1.54	0.7	1/4"	3/8"	11
19TTA06Q	10 - 45	1.1 - 5.1	10 - 38	1.1 - 4.3	260	8.3	210	1.54	0.7	1/4"	3/8"	11
19TTA07Q	15 - 60	1.7 - 6.8	24 - 60	2.7 - 6.8	660	8.3	210	1.54	0.7	1/4"	3/8"	11
19TTA09Q	15 - 79	1.7 - 8.9	24 - 79	2.7 - 8.9	470	9.3	235	1.73	0.8	1/4"	3/8"	11
19TTA15Q	45 - 130	5.1 - 14.7	45 - 130	5.1 - 14.7	260	9.6	243	1.94	0.9	1/4"	3/8"	11

**General:**

Tool performance rated at 90 psi (620kPa) air pressure.

**Standard Equipment:**

Operating instructions & service manual  
Suspension bail

Dead handle on models above 100 in.-lbs. torque cap.

All torque springs required to meet indicated torque specification

**Optional Equipment:**

Additional accessories: Pages 12-13

Torque Springs: Page 13

Torque Signal Kit: 302021PT  
(Trigger w/Clecomatic clutch only)  
Overhose: 207107  
Push-only Conversion Kit: 301121

Model Number	Torque Range				Free Speed	Length		Weight		Air Consumption		
	Tool Range		With Std. Spring			in.	mm	lbs.	kg	Air Inlet NPT	Min. Hose I.D.	SCFM
1/4" Quick Change	in.-lbs.	Nm	in.-lbs.	Nm	RPM							

**Push and Trigger Start - P Handle - Clecomatic Clutch**

19PCA02Q	5 - 19	0.6 - 2.1	5 - 19	0.6 - 2.1	2800	8.1	206	1.41	0.6	1/4"	3/8"	11
19PCA03Q	5 - 26	0.6 - 2.9	5 - 19	0.6 - 2.1	1900	8.3	211	1.51	0.7	1/4"	3/8"	11
19PCA04Q	10 - 40	1.1 - 4.5	10 - 38	1.1 - 4.3	1100	8.1	206	1.41	0.6	1/4"	3/8"	11
19PCA05Q	10 - 45	1.1 - 5.1	10 - 38	1.1 - 4.3	660	8.5	216	1.51	0.7	1/4"	3/8"	11
19PCA06Q	10 - 45	1.1 - 5.1	10 - 38	1.1 - 4.3	260	8.5	216	1.51	0.7	1/4"	3/8"	11
19PCA07Q	15 - 60	1.7 - 6.8	24 - 60	2.7 - 6.8	660	8.5	216	1.51	0.7	1/4"	3/8"	11
19PCA09Q	15 - 79	1.7 - 8.9	24 - 60	2.7 - 8.9	470	9.8	248	1.65	0.7	1/4"	3/8"	11

**Trigger Start - P Handle - Clecomatic Clutch**

19PTA02Q	5 - 19	0.6 - 2.1	5 - 19	0.6 - 2.1	2800	8.0	204	1.41	0.6	1/4"	3/8"	11
19PTA03Q	5 - 26	0.6 - 2.9	5 - 19	0.6 - 2.1	1900	8.2	209	1.51	0.7	1/4"	3/8"	11
19PTA04Q	10 - 40	1.1 - 4.5	10 - 38	1.1 - 4.3	1100	8.0	204	1.41	0.6	1/4"	3/8"	11
19PTA05Q	10 - 45	1.1 - 5.1	10 - 38	1.1 - 4.3	660	8.4	214	1.51	0.7	1/4"	3/8"	11
19PTA06Q	10 - 45	1.1 - 5.1	10 - 38	1.1 - 4.3	260	8.4	214	1.51	0.7	1/4"	3/8"	11
19PTA07Q	15 - 60	1.7 - 6.8	24 - 60	2.7 - 6.8	660	8.4	214	1.51	0.7	1/4"	3/8"	11
19PTA09Q	15 - 79	1.7 - 8.9	24 - 79	2.7 - 8.9	470	9.8	248	1.65	0.7	1/4"	3/8"	11
19PTA15Q	45 - 130	5.1 - 14.7	45 - 130	5.1 - 14.7	260	9.7	247	1.91	0.9	1/4"	3/8"	11

**General:**

Tool performance rated at 90 psi (620kPa) air pressure.

**Standard Equipment:**

Operating instructions & service manual  
Suspension bail

Dead handle on models above 100 in.-lbs. torque cap.

All torque springs required to meet indicated torque specification

**Optional Equipment:**

Additional accessories: Pages 12-13

Torque Springs: Page 13

Torque Signal Kit: 302021PT  
(Trigger w/Clecomatic clutch only)

# Pistol Grip Screwdrivers

88 & 35 Series Clecomatic Clutch

## Cleco®

### 88 Series

**Torque Range: 1.7 – 20 Nm 15 – 180 In. Lbs.**

- Quick change and square drive
- Reversible
- Trigger and Push & Trigger start



### 35 Series

**Torque Range: 1.7 – 20 Nm 15 – 180 In. Lbs.**

- Pistol grip
- Quick change and square drive
- Reversible
- Trigger, Push-to-Start and Push & Trigger start

Model Number		Torque Range		Free Speed	Length		Weight		Air Consumption		
1/4" Hex Quick Change	3/8" Square Drive	in.-lbs.	Nm	RPM	in.	mm	lbs.	kg	Air Inlet	Min.	SCFM
									NPT	Hose I.D.	
<b>Push and Trigger Start - Sliding Knob Reverse</b>											
88RSAPT-7CQ		15 - 95	1.7 - 10	550	9.0	229	3.1	1.4	1/4"	1/4"	19
88RSAPT-5CQ	88RSAPT-5C-3	15 - 160	1.7 - 18	400	9.0	229	3.1	1.4	1/4"	1/4"	19
88RSAPT-2CQ		15 - 180	1.7 - 20	200	9.8	248	3.4	1.5	1/4"	1/4"	19
<b>Trigger Start - Sliding Knob Reverse</b>											
88RSATP-7CQ	88RSATP-7C-3	15 - 95	1.7 - 10	550	8.9	225	3.1	1.4	1/4"	1/4"	19
88RSATP-5CQ	88RSATP-5C-3	15 - 160	1.7 - 18	400	8.9	225	3.1	1.4	1/4"	1/4"	19
88RSATP-2CQ	88RSATP-2C-3	15 - 180	1.7 - 20	200	9.6	245	3.4	1.5	1/4"	1/4"	19

**General:**

Tool performance rated at 90 psi (620kPa).  
Weight does not include dead handle

**Standard Equipment:**

Operating instructions & service manual  
Dead handle on all models above 100 in.lbs. torque  
All torque springs required to meet indicated torque

**Standard Equipment if Specified:**

Dead handle (861006)

**Optional Equipment:**

Additional accessories: Pages 12-13  
Bits & finders: Page 12  
Torque Springs: Page 13

Model Number		Torque Range		Free Speed	Length		Weight		Air Consumption		
1/4" Hex Quick Change	3/8" Square Drive	in.-lbs.	Nm	RPM	in.	mm	lbs.	kg	Air Inlet	Min.	SCFM
									NPT	Hose I.D.	
<b>Push-to-Start - Sliding Knob Reverse</b>											
35RSAP-10Q		15 - 110	2 - 12	770	9.9	251	3.4	1.5	1/4"	5/16"	24
35RSAP-7Q		15 - 160	2 - 18	510	9.9	251	3.4	1.5	1/4"	5/16"	24
<b>Push and Trigger Start - Sliding Knob Reverse</b>											
35RSAPT-7Q		15 - 160	2 - 18	500	9.9	251	3.4	1.5	1/4"	5/16"	24
35RSAPT-5Q		15 - 180	2 - 20	350	9.9	251	3.4	1.5	1/4"	5/16"	24
<b>Trigger Start - Sliding Knob Reverse</b>											
35RSATP-20Q		15 - 60	2 - 7	1500	9.0	229	3.1	1.4	1/4"	5/16"	24
35RSATP-10Q	35RSATP-10-3	15 - 110	2 - 12	750	9.8	248	3.4	1.5	1/4"	5/16"	24
35RSATP-7Q		15 - 160	2 - 18	500	9.8	248	3.4	1.5	1/4"	5/16"	24
35RSATP-5Q	35RSATP-5-3	15 - 180	2 - 20	350	9.8	248	3.4	1.5	1/4"	5/16"	24

**General:**

Tool performance rated at 90 psi (620kPa).  
Weight does not include dead handle

**Standard Equipment:**

Operating instructions & service manual  
Dead handle on all models above 100 in.lbs. torque  
All torque springs required to meet indicated torque

**Standard Equipment if Specified:**

Dead handle (861006)

**Optional Equipment:**

Additional accessories: Pages 12-13  
Torque Springs: Page 13

# Cleco®

## 19 Series Stall

**Torque Range: 2.1 – 7.9 Nm 19 – 70 In. Lbs.**

- 1/4" hex quick change drive
- Trigger start
- "P" and "T" style handles (19 series)
- 2 interchangeable soft-touch grip sizes (19 Series)
- Adjustable reverse lever for true one-hand - left or right - operation (19 series)
- Sliding knob or push button reverse (8 series)



Model Number	Torque Range		Free Speed	Length		Weight		Air Consumption		
	in.-lbs.	Nm	RPM	in.	mm	lbs.	kg	Air Inlet NPT	Min. Hose I.D.	SCFM
<b>1/4" Quick Change</b>										
<b>Trigger Start - T Handle - Sliding Knob Reverse</b>										
19TTS02Q	19	2.1	2800	5.8	146	1.19	0.5	1/4"	3/8"	11
19TTS03Q	26	2.9	1900	6.1	154	1.19	0.5	1/4"	3/8"	11
19TTS04Q	40	4.5	1100	5.8	146	1.19	0.5	1/4"	3/8"	11
19TTS05Q	45	5.1	660	6.1	154	1.19	0.5	1/4"	3/8"	11
8RNP-20BQ	44	5.0	1800	5.4	137	2.1	1.0	1/4"	1/4"	19
8RNP-10BQ	70	7.9	800	6.1	156	2.4	1.1	1/4"	1/4"	19
<b>Trigger Start - P Handle - Sliding Knob Reverse</b>										
19PTS02Q	19	2.1	2800	5.9	150	1.16	0.5	1/4"	3/8"	11
19PTS03Q	26	2.9	1900	6.1	155	1.16	0.5	1/4"	3/8"	11
19PTS04Q	40	4.5	1100	5.9	150	1.16	0.5	1/4"	3/8"	11
19PTS05Q	45	5.1	660	6.1	155	1.16	0.5	1/4"	3/8"	11

**General:**  
Tool performance rated at 90 psi (620kPa).

**Standard Equipment:**  
Operating instructions & service manual  
Suspension bail  
All torque springs required to meet indicated torque

Dead handle on all models above 100 in.lbs. torque

**Standard Equipment if Specified:**  
Dead handle (861006; 8 series models)

**Optional Equipment:**  
Additional accessories: Pages 12-13  
Bits: Page 12

# Screwdriver Accessories

## Standard and Extended Flat Bits and Finders

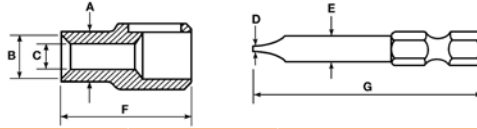

Screw Size	Standard Length (F=1 3/16 in.; G= 1 15/16 in.)		Finder Dimensions (in.)			Bit Dimensions (in.)		Extended Length (F=2 1/4 in.; G= 3 in.)	
	Bit No.	Finder No.	A	B	C	D	E	Bit No.	Finder No.
1F- 2R	849617	847299	.22	.169	.128	.122	.122	849891	847481
2F- 3R	849843	863242	.250	.196	.140	.028	.134	849879	847480
3F- 4R	849618	847300	.285	.228	.160	.032	.154	849892	847482
4F- 5R	849153	847301	.315	.259	.193	.034	.187	849893	847483
5F- 6R	849619	847302	.345	.291	.221	.036	.215	849894	847484
6F- 8R	849154	847303	.380	.323	.256	.038	.250	849895	847485
8F-10R	849620	847294	.445	.386	.281	.042	.275	849896	847486
10F-12R	849155	847304	.530	.431	.318	.046	.312	849897	847487
12F-14R	849156	847305	.590	.513	.366	.050	.360	849898	847488

## Finder Springs

### Light Force

844000

### Medium Force

865728

## Phillips Bits and Support Bushings



Phillips Bit Point Size	Bit Body Diameter (in.)	Phillips Bit Part No.	Support Bushing* Part No.
<b>Standard:</b> 1/4 in. Hex Shank Bit – 2 3/4 in. O.A. Length; Bushing – 1 3/16 in. O.A. Length			
1	3/16	809451	847301
2	1/4	809470	847303
3	5/16	809471	847304
<b>Extended:</b> 1/4 in. Hex Shank Bit – 3 1/2 in. O.A. Length; Bushing – 2 1/4 in. O.A. Length			
1	3/16	809453	847483
2	1/4	809473	847485
3	5/16	809474	847487

## Bit Holders and Support Bushings



**1/4" Hex Drive Magnetic Bit Holder**  
Part No. 849325 (2 3/8" O.A. Length)  
**Magnetic Support Bushing\*** Part No. 849621  
**Nonmagnetic Support Bushing\*** Part No. 847245  
**Quick-Change Bushing** Part No. 201203  
Fits all finder type tools except No. 2 Screwdriver  
*\*Bushing not required on Quick Change models.*

\*Bushing not required on Quick Change models.

## Screw Sizes & Types



Screw Size	Approximate Thread Body Diameter (inches)	Maximum Head Diameter (inches)							Width of Slot Max. - Min. (inches)
		Round Head	Flat Head	Oval Head	Fillister Head	Pan Head	Binding Head	Truss Head	
0	.058	.113	.119	.119	.096	.116	-	.131	.023 - .016
1	.071	.138	.146	.146	.118	.142	-	.164	.026 - .019
2	.084	.162	.172	.172	.140	.167	.181	.194	.031 - .023
3	.096	.187	.199	.199	.161	.193	.208	.226	.035 - .027
4	.109	.211	.225	.225	.183	.219	.235	.257	.039 - .031
5	.122	.236	.252	.252	.205	.245	.263	.289	.043 - .035
6	.135	.260	.279	.279	.226	.270	.290	.321	.048 - .039
8	.161	.309	.332	.332	.270	.322	.344	.384	.054 - .045
10	.187	.359	.385	.385	.313	.373	.399	.448	.060 - .050
12	.213	.408	.438	.438	.357	.425	.454	.511	.067 - .056
1/4	.247	.472	.507	.507	.414	.492	.513	.573	.075 - .064
5/16	.309	.590	.635	.635	.518	.615	.641	.698	.084 - .072

## Inline Screwdriver Clutch Torque Springs

Spring Color	Torque Range		Ordering No.
	In. Lbs.	Nm	
<b>2 Series</b>			
Blue	1.5-.5	17-.06	202870
Green	8-1	.9-.1	202869
<b>19 Series</b>			
Green	19-5	--	207652PT
White	38-10	4.3-1.1	207596PT
Orange	45-15	5.1-1.7	207696PT
<b>8 Series</b>			
Blue	17-7	1.9-.8	869203
Green	55-15	6.2-1.7	867938
Red	75-35	8.5-4	867931
<b>88, 35 Series</b>			
Green	55-15	6-2	202822
Yellow	160-35	18-4	869306
Red	180-60	20-7	869305

Note: Torque listed is immediately after the clutch and does not take into consideration torque multiplication after the clutch, such as additional planetary gears or right angle heads.



## Exhaust Overhose & Adapter

Order No.	Description	Used On
207019	Overhose	19 series inline & right angle
869204	Adapter	8, 88, 35 series inline, push-to-start

## Piped Away Exhaust Hose Adapter

Order No.	Used On
203632	5 series inline
203808	8, 88, 35 series inline p-t-start



## Dead Handle

Ordering No.	Used On
201770	5 series, 19 series
861006	8, 88, 35 series



## Handle Grips

Order No.	Grip Type	Used On
202464	Round inline	2 series
869734	Round inline	5 series
203621	Tri-roundular inline	5 series
202346	Round inline	8 series p-t-start
203762	Pistol grip	5 series
203833	Pistol grip	8, 88, 35 series



## Suspension Bails

Order No.	Used On
931962	19 series
869168	2 series
865777	5 series inline & 8, 88 series inline push-to-start
412603	5 series pistol grip & 8, 88 series inline lever start



## Torque Signal Kits

Part No.	Tool Used On
301106	19SCA & 19RAA series (inline & right angle)
302021PT	19TTA & 19PTA series (pistol "P" handle or "T" handle)

## Portable Tool Balancers

Part Number	Capacity		Net Weight	Min. Distance Hook to Hook	Length of Working Cable
	Max.	Min.			
200427	2 lbs.	0 lbs.	1.25 lbs.	10.8 in.	5.0 ft.
200428	4 lbs.	2 lbs.	1.25 lbs.	10.8 in.	5.0 ft.
200429	5 lbs.	3 lbs.	1.25 lbs.	10.8 in.	5.0 ft.
PL-12A	12 lbs.	1 lbs.	-	6.8 in.	4.6 ft.
BL-2A	2 lbs.	1 lbs.	1.1 lbs.	10.4 in.	5.2 ft.
BL-4A	4 lbs.	2 lbs.	1.1 lbs.	10.4 in.	5.2 ft.



# Screwdrivers

Model Number Nomenclature

## Cleco 2 Series

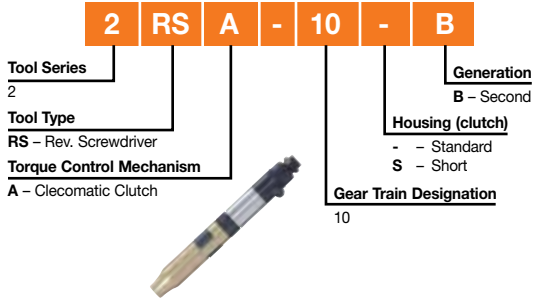

## Cleco 19 Series Inline

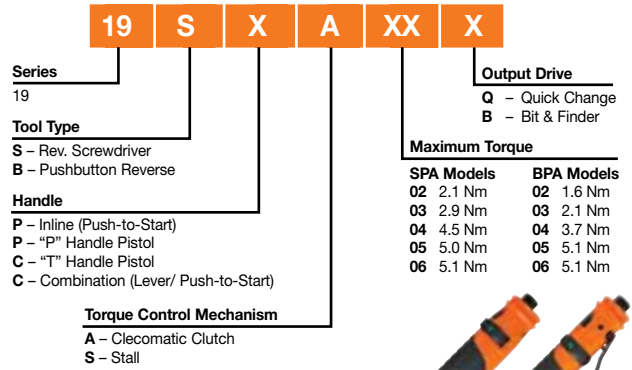

## Cleco 19 Series Pistol

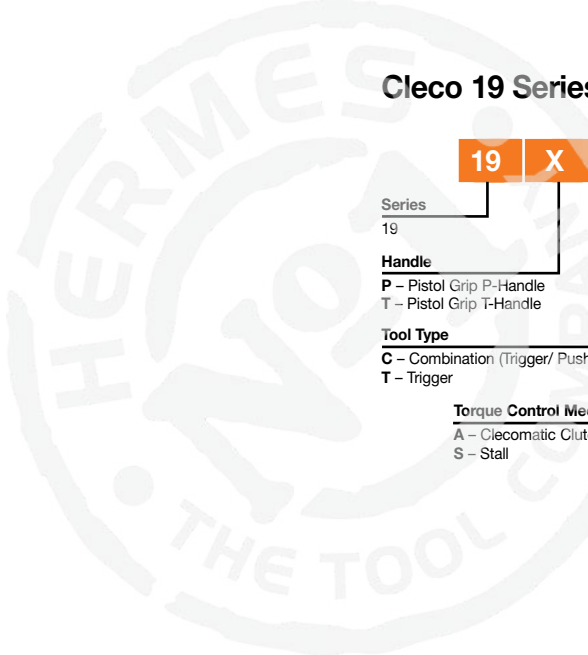
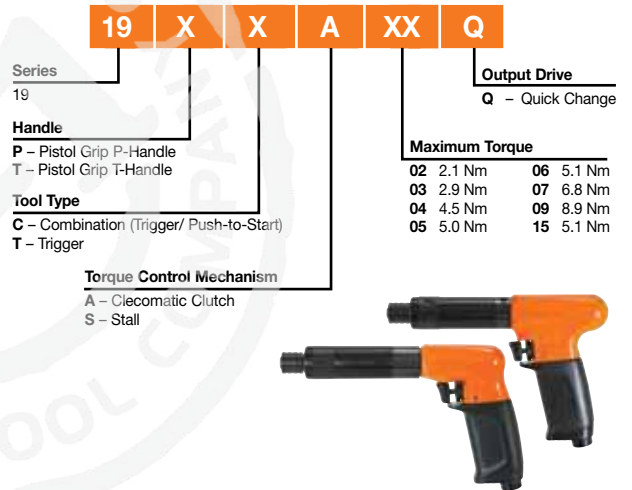

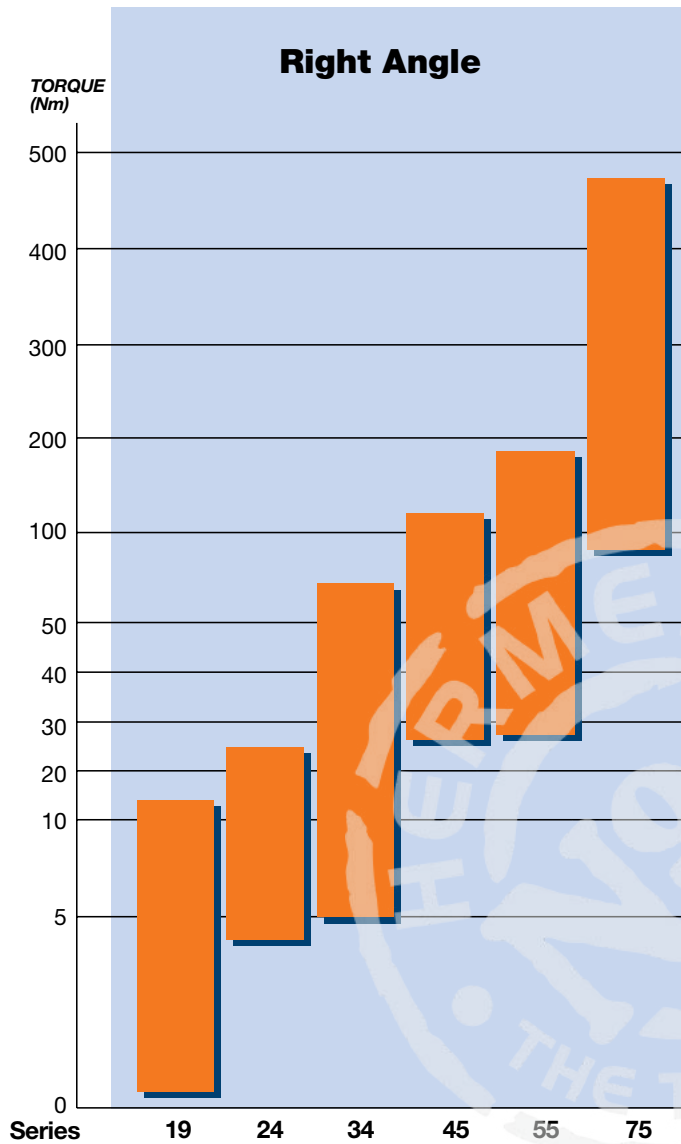

## Cleco®

### Selecting Your Cleco Nutrunner

Cleco offers over 500 nutrunners, most of which can be equipped with a wide variety of drive options. This generates over 3,000 different nutrunner combinations, allowing the exact tool with precise features to be chosen for specific job applications.

The following items should be considered before selecting the tool: ergonomic factors associated with the man/tool/task relationship, torque and speed requirements, tool and fastener accessibility, fastener joint variations, operator skill level and air supply.

Tool performance can be affected by air supply. Plant air line pressure to the tool will vary widely due to several factors: distance of tool from compressor; size of transmission lines, air drops, manifolds, hose length and diameter, and fittings. All power tool specifications are based on the tool receiving air at 90 p.s.i.g. (6.2 bar) with adequate air flow volume while the tool is in operation.

### Clean Operation

Many Cleco angle nutrunners are equipped with oilless blades. This is a very important feature where a clean assembly operation is critical.





# Angle Nutrunners

## Clecomatic Nutrunners

Clecomatic nutrunners shut off the instant the clutch reaches its adjustable preset torque. This action provides an accurate method of controlling torque without sacrificing tool speed.

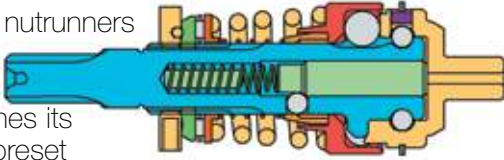

## Stall Nutrunners

Stall-type nutrunners consist of an air motor connected to the output spindle by planetary gearing and angle heads. In operation, the tool runs down the fastener until the torque resistance in the fastener causes the tool to stall. When the tool stalls, the throttle is released by the operator and the tool is removed. Stall-type tools can produce accurate torques, especially on applications with varying torque rates; however, their torque output can be

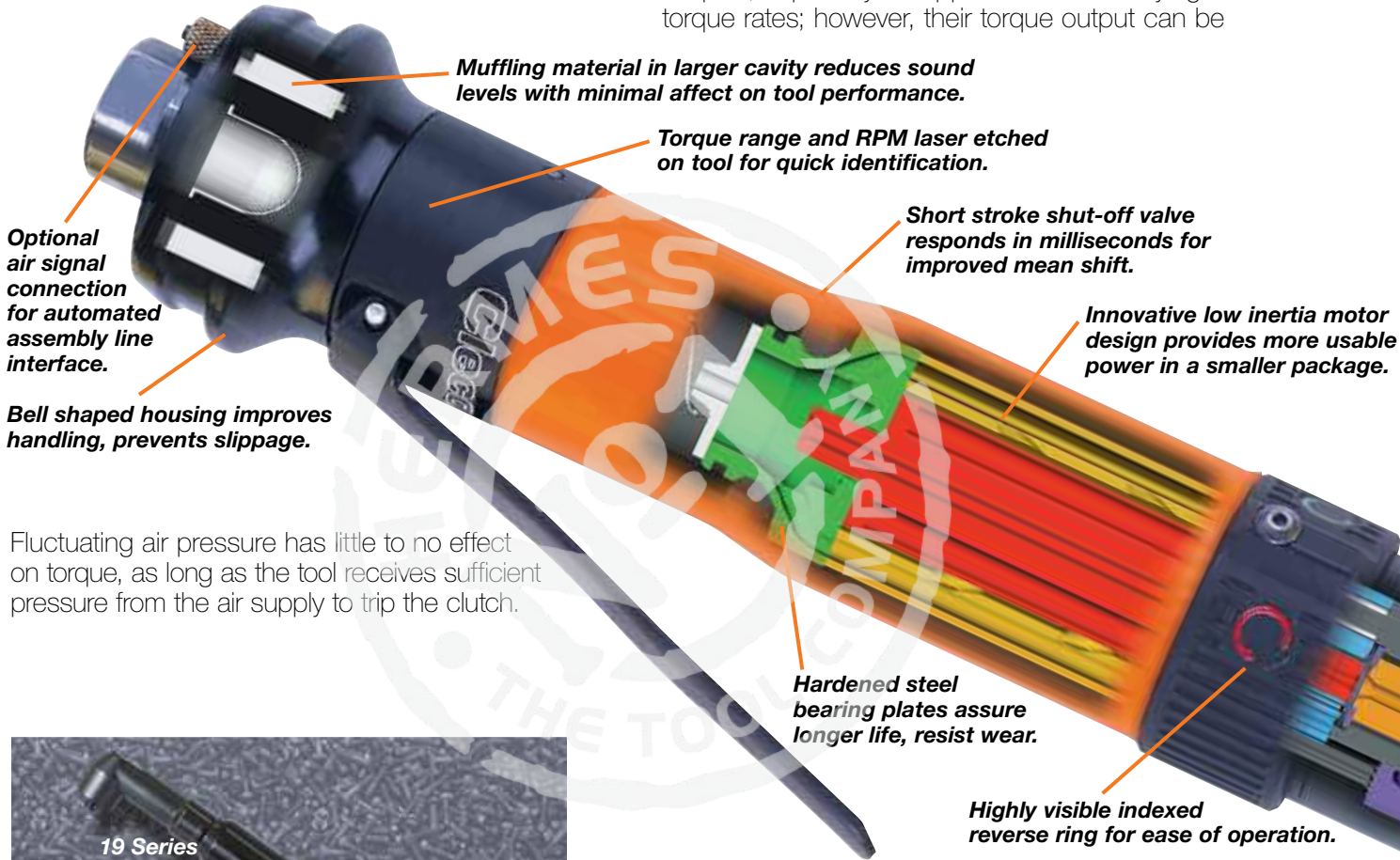

Fluctuating air pressure has little to no effect on torque, as long as the tool receives sufficient pressure from the air supply to trip the clutch.



easily influenced by the operator and by fluctuations in the air line pressure. Operators should be instructed to allow the tool to stall before releasing the throttle and to avoid pulling or wrenching the tool after it stalls.

## The Cleco Right Angle Solution

The Cleco 19, 24 and 34 series pneumatic nutrunners are the most recent additions to our line of smaller, lighter and faster tools. These powerful right angle clutch tools cover a wide torque range from .5 to 68 NM. We continue to drive our line into the best power to weight ratio of any other tool in the market, in a relentless effort to offer the most performance, the highest level of accuracy and the greatest flexibility in its class of pneumatic tools.

We also design our tools to offer you reduced energy costs, longer operating life, fewer replacement parts and lower service costs.



## Performance

The Cleco 19, 24 and 34 series right angle nutrunners incorporate an innovative motor design that provides more usable power in a smaller package. This design contributes greatly to our smaller, lighter, faster goals and provides the highest power to weight ratio in its class to date.

## Flexibility

Cleco nutrunners come with an externally adjusted and indicated clutch and offer improved ergonomics with a very comfortable handle area. The polymer coated angle heads on the 24 and 34 series reduce in-system damage. These durable heads are splined to allow indexing for better position. The operator will appreciate a quieter tool thanks to the composite exhaust deflector which also allows the exhaust to be efficiently piped away for even further reduced noise levels. These noted improvements are geared towards enhancing the tools positive operational features while reducing operator fatigue.

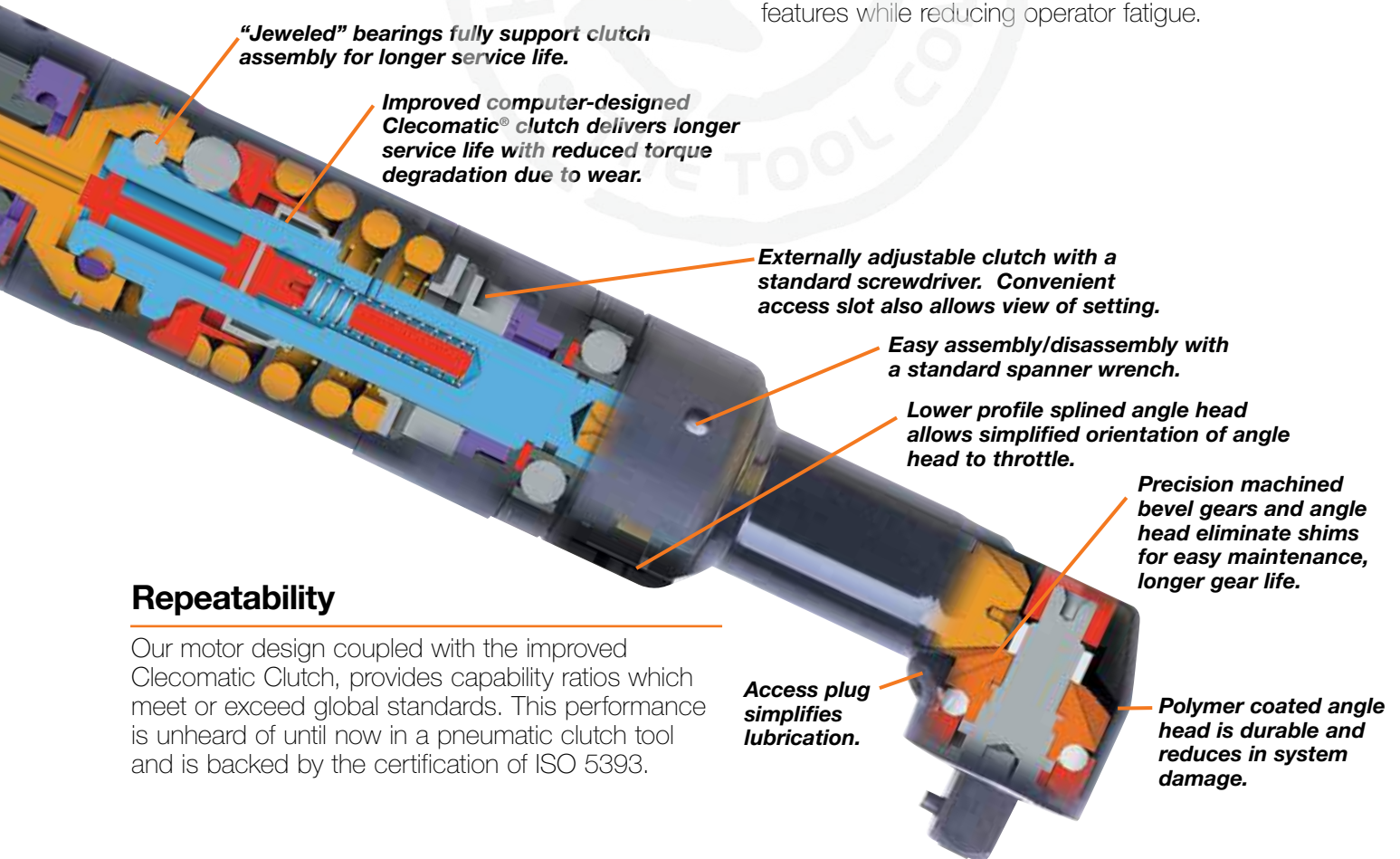

**“Jeweled” bearings fully support clutch assembly for longer service life.**

**Improved computer-designed Clecomatic® clutch delivers longer service life with reduced torque degradation due to wear.**

**Externally adjustable clutch with a standard screwdriver. Convenient access slot also allows view of setting.**

**Easy assembly/disassembly with a standard spanner wrench.**

**Lower profile splined angle head allows simplified orientation of angle head to throttle.**

**Precision machined bevel gears and angle head eliminate shims for easy maintenance, longer gear life.**

**Access plug simplifies lubrication.**

**Polymer coated angle head is durable and reduces in system damage.**

## Repeatability

Our motor design coupled with the improved Clecomatic Clutch, provides capability ratios which meet or exceed global standards. This performance is unheard of until now in a pneumatic clutch tool and is backed by the certification of ISO 5393.

# Angle Nutrunners

19, 24 & 34 Series Clecomatic Clutch

## Cleco®

### 19 Series

**Torque Range:**

0.5 – 11 Nm 4.0 – 100 In. Lbs.

- Class-leading accuracy and repeatability
- External torque adjustment
- Sliding knob reverse
- 1/4" & 3/8" square drive

### 24 Series

**Torque Range:**

4.0 – 23 Nm 3.0 – 17 Ft. Lbs.

- External torque adjustment
- 3/8" square drive
- Indexable anglehead
- One torque spring to meet specified torque
- Oilless blades 🔥

### 34 Series

**Torque Range:**

8.0 – 75 Nm 4.0 – 55 Ft. Lbs.

- External torque adjustment
- 3/8" and 1/2" square drive
- Indexable anglehead
- One torque spring to meet specified torque
- Oilless blades 🔥



### Model Number Example

24	R	A	A	23	A	M	3
<b>Series</b>	<b>Rotation</b>			<b>Angle Head Size</b>			<b>Square Drive</b>
19	R-Reversible			L - Light Duty			2 - 1/4" (AL only)
24				M - Medium Duty			3 - 3/8"
34				H - Heavy Duty			4 - 1/2" (AZ only)
	<b>Tool Style</b>			<b>Maximum Torque Nm</b>			<b>Angle Head Size</b>
	A - Right Angle			(Rounded to the nearest Nm)			L - Light Duty
	<b>Torque Control</b>						M - Medium Duty
	A - Clecomatic						H - Heavy Duty
	S - Stall						X - Extra Heavy Duty
							Z - Super Heavy Duty
							<b>Tool Termination</b>
							A Angle head

Model Number		Torque Range*				Free Speed	Length		Weight		Head Height		Side to Center		Air Consumption		
1/4" Sq. Dr.	3/8" Sq. Dr.	Tool Range		With Std. Spring			RPM	in.	mm	lbs.	kg	in.	mm	in.	mm	Air Inlet NPT	Min. Hose I.D.
<b>19 Series - Reversible – Clecomatic Clutch</b>																	
19RAA02AM2		5 - 19	0.6 - 2.1	5 - 19	0.6 - 2.1	2400	11.9	303	1.7	0.8	1.06	27	0.36	9	1/8"	3/16"	11
19RAA02AH2	19RAA02AH3	6 - 21	0.7 - 2.4	6 - 21	0.7 - 2.4	2100	12.5	316	1.8	0.8	1.19	30	0.50	13	1/8"	3/16"	11
19RAA03AM2		5 - 27	0.6 - 3.1	5 - 21	0.6 - 2.4	1650	12.2	310	1.8	0.8	1.06	27	0.36	9	1/8"	3/16"	11
19RAA03AH2	19RAA03AH3	6 - 30	0.7 - 3.4	6 - 24	0.7 - 2.7	1450	12.7	321	1.8	0.8	1.19	30	0.50	13	1/8"	3/16"	11
19RAA04AM2		12 - 42	1.4 - 4.7	12 - 42	1.4 - 4.7	950	12.0	305	1.7	0.8	1.06	27	0.36	9	1/8"	3/16"	11
19RAA05AM2		12 - 50	1.4 - 5.7	12 - 42	1.4 - 4.7	570	12.4	316	1.8	0.8	1.06	27	0.36	9	1/8"	3/16"	11
19RAA06AH2*	19RAA06AH3	13 - 53	1.5 - 6.0	13 - 48	1.5 - 5.4	850	12.5	316	1.8	0.8	1.19	30	0.50	13	1/8"	3/16"	11
19RAA07AH2*	19RAA07AH3	13 - 60	1.5 - 6.8	13 - 48	1.5 - 5.4	500	12.9	326	1.9	0.9	1.19	30	0.50	13	1/8"	3/16"	11
19RAA09AH2*	19RAA09AH3	18 - 75	2.0 - 8.5	30 - 75	3.4 - 8.5	500	12.9	326	1.9	0.9	1.19	30	0.50	13	1/8"	3/16"	11
19RAA11AH2*	19RAA11AH3	18 - 100	2.0 - 11.3	30 - 100	3.4 - 11.3	340	12.3	312	2.1	1.0	1.19	30	0.50	13	1/8"	3/16"	11
19RAA12AH2*	19RAA12AH3	18 - 100	2.0 - 11.3	30 - 100	3.4 - 11.3	200	12.9	326	1.9	0.9	1.19	30	0.50	13	1/8"	3/16"	11

\*Applications greater than 50 in.-lbs. may affect spindle/drive durability.

**General:**

Tool performance rated at 90 psi (620kPa) air pressure.

**Standard Equipment:**

Operating instructions & service manual.

**Suspension bail.**

All torque springs required to meet indicated torque specification.

**Optional Equipment:**

Additional accessories: Page 36

Non-Reverse Kit: 207030

Torque Signal Kit: 301106 (Clecomatic clutch only)

**Overhose: 207019**

Quick Change and 1/4" magnetic hex outputs available on AH3 models only.

Quick Change: Change AH3 to AHQ

1/4" Magnetic Hex: Change AH3 to AHM

Model Number		Torque Range		Free Speed	Length		Weight		Head Height		Side to Center		Air Consumption		
3/8" Sq. Dr.	1/2" Sq. Dr.	ft.-lbs.	Nm		RPM	in.	mm	lbs.	kg	in.	mm	in.	mm	Air Inlet NPT	Min. Hose I.D.
<b>24 Series – Reversible – Clecomatic Clutch</b>															
24RAA06AL3		3-4	4-5.5	2200	14.1	358	2.6	1.2	1.08	27.5	.47	12.0	3/8"	5/16"	24
24RAA07AL3		3-5	5-7	1770	14.1	358	2.6	1.2	1.08	27.5	.47	12.0	3/8"	5/16"	24
24RAA11AL3		5-8	7-11	1260	14.1	358	2.6	1.2	1.08	27.5	.47	12.0	3/8"	5/16"	24
24RAA12AM3		5-9	6-12	1200	14.2	360	2.8	1.3	1.16	29.5	.52	13.2	3/8"	5/16"	24
24RAA19AM3		7-14	10-19	700	15.0	380	3.2	1.4	1.16	29.5	.52	13.2	3/8"	5/16"	24
24RAA23AM3		9-17	12-23	600	15.0	380	3.2	1.4	1.16	29.5	.52	13.2	3/8"	5/16"	24
<b>34 Series – Reversible – Clecomatic Clutch</b>															
34RAA08AL3		4-6	8-5	2060	14.5	368	2.7	1.2	1.08	27.5	.47	12.0	3/8"	5/16"	34
34RAA11AL3		5-8	7-11	1675	14.5	368	2.7	1.2	1.08	27.5	.47	12.0	3/8"	5/16"	34
34RAA15AM3		7-11	9-15	1185	14.6	370	2.9	1.3	1.16	29.5	.52	13.2	3/8"	5/16"	34
34RAA26AH3		10-19	13-26	710	15.4	390	3.2	1.5	1.22	31.0	.57	14.4	3/8"	5/16"	34
34RAA28AH3		10-20	14-28	580	15.4	390	3.3	1.5	1.22	31.0	.57	14.4	3/8"	5/16"	34
34RAA33AX3		12-24	17-33	545	15.5	393	3.5	1.6	1.36	34.5	.67	17.1	3/8"	5/16"	34
34RAA37AX3		14-27	18-37	480	15.6	397	3.4	1.5	1.36	34.5	.67	17.1	3/8"	5/16"	34
34RAA47AX3		17-35	24-47	385	15.6	397	3.4	1.5	1.36	34.5	.67	17.1	3/8"	5/16"	34
34RAA68AZ3		25-50	34-68	255	16.2	411	3.7	1.7	1.60	41.0	.70	18.0	3/8"	5/16"	34
34RAA75AZ3		28-55	38-75	155	17.0	431	3.9	1.8	1.60	41.0	.70	18.0	3/8"	5/16"	34
	34RAA68AZ4	25-50	34-68	255	16.2	411	3.7	1.7	1.60	41.0	.70	18.0	3/8"	5/16"	34
	34RAA75AZ4	28-55	38-75	155	17.0	431	3.9	1.8	1.60	41.0	.70	18.0	3/8"	5/16"	34

**General:**

Tool performance rated at 90 psi (620kPa) air pressure.

**Standard Equipment:**

Operating instructions & service manual  
Suspension bail  
Clutch adjustment tool

**Optional Equipment:**

Assembly wrench: 201898  
Torque signal kit: 301937PT  
Non-reversible kit: 204999  
Exhaust Overhose: 204978  
Additional accessories: Page 36

# Angle Nutrunners

45, 55 & 75 Series Clecomatic Clutch

## Cleco®

### 45 Series

**Torque Range:**  
28 – 115 Nm 21 – 85 Ft. Lbs.

- Button start
- Reversible & non-reversible
- External torque adjustment
- 1/2" square drive

### 55 Series

**Torque Range:**  
32 – 176 Nm 24 – 130 Ft. Lbs.

- Lever start
- Reversible & non-reversible
- External torque adjustment
- Rotating exhaust deflector
- 1/2" square drive

### 75 Series

**Torque Range:**  
95 – 430 Nm 70 – 320 Ft. Lbs.

- Lever start
- Reversible & non-reversible
- External torque adjustment
- Rotating exhaust deflector
- 1/2" & 3/4" square drive



### 45, 55 & 75 Model Number Example

<b>55</b>	<b>R</b>	<b>N</b>	<b>A</b>	<b>L</b>	<b>-</b>	<b>XX</b>	<b>X</b>	<b>-</b>	<b>X</b>
<b>Series</b> 45, 55, 75	<b>Rotation</b> N-Non Reversible R-Reversible		<b>Nutrunner</b>			<b>Torque Control</b> A – Clecomatic -- Stall	<b>Start Type</b> L – Lever B – Button	<b>Gear Train</b> 2, 3, 4, 6, 7, 10	<b>Sq. Drive</b> 3 – 3/8" 4 – 1/2" 6 – 3/4" <b>Angle Head</b> P, T, V, X

Model Number	Torque Range		Free Speed	Length		Weight		Head Height		Side to Center		Angle Head	Air Consumption			
	1/2" Sq. Dr.	ft.-lbs.		Nm	RPM	in.	mm	lbs.	kg	in.	mm		in.	mm	Air Inlet NPT	Min. Hose I.D.
<b>45 Series – Clecomatic Clutch – Button Start – Reversible</b>																
45RNAB-4T-4		21 - 42	28 - 57	300	17.6	448	6.8	3.1	2.0	50	0.9	22	T	3/8"	3/8"	33
45RNAB-3P-4		26 - 52	35 - 71	240	17.5	445	6.4	2.9	1.6	41	0.7	18	P	3/8"	3/8"	33
45RNAB-3T-4		31 - 62	42 - 84	200	17.6	448	6.8	3.1	2.0	50	0.9	22	T	3/8"	3/8"	33
45RNAB-2P-4		34 - 71*	46 - 96*	180	17.5	445	6.4	2.9	1.6	41	0.7	18	P	3/8"	3/8"	33
45RNAB-2T-4		37 - 85	50 - 115	150	17.6	448	6.8	3.1	2.0	50	0.9	22	T	3/8"	3/8"	33
<b>45 Series Clecomatic Clutch – Button Start – Non-Reversible</b>																
45NAB-3P-4		28 - 57	38 - 77	300	17.5	445	6.3	2.8	1.6	41	0.7	18	P	3/8"	3/8"	33

\* Maximum torque of tool exceeds the maximum torque rating for the head, high maintenance should be expected when operated at the upper torque capacity range.

**General:**  
Tool performance rated at 90 psi (620kPa) air pressure.

**Standard Equipment:**  
Operating instructions & service manual.  
All torque springs required to meet indicated torque

**Optional Equipment:**  
Additional accessories: Page 36

Model Number	Torque Range		Free Speed	Length		Weight		Head Height		Side to Center		Angle Head	Air Consumption			
	1/2" Sq. Dr.	3/4" Sq. Dr.		ft.-lbs.	Nm	RPM	in.	mm	lbs.	kg	in.		mm	in.	mm	Air Inlet NPT
<b>55 &amp; 75 Series – Lever Start – Reversible</b>																
55RNAL-6T-4		24 - 48	32 - 65	370	19.3	489	7.8	3.5	2.0	50	0.9	22	T	1/2"	1/2"	55
55RNAL-4P-4		26 - 54	35 - 73	330	19.1	486	7.4	3.3	1.6	41	0.7	18	P	1/2"	1/2"	55
55RNAL-4T-4		29 - 64	39 - 87	280	19.3	489	7.8	3.5	2.0	50	0.9	22	T	1/2"	1/2"	55
55RNAL-3P-4		36 - 80*	49 - 109*	220	19.1	486	7.4	3.3	1.6	41	0.7	18	P	1/2"	1/2"	55
55RNAL-3T-4		43 - 95	58 - 129	190	19.3	489	7.8	3.5	2.0	50	0.9	22	T	1/2"	1/2"	55
55RNAL-2T-4		50 - 125*	81 - 170*	140	19.3	489	7.8	3.5	2.0	50	0.9	22	T	1/2"	1/2"	55
75RNAL-3V-4		70 - 140	95 - 190	175	21.9	556	13.3	6.0	2.5	64	1.1	28	V	1/2"	1/2"	70
75RNAL-2V-4		90 - 190*	122 - 255*	130	21.9	556	13.3	6.0	2.5	64	1.1	28	V	1/2"	1/2"	70
	75RNAL-3X-6	110 - 225	150 - 305	110	22.6	575	15.0	6.8	2.8	70	1.4	37	X	1/2"	1/2"	70
	75RNAL-2X-6	150 - 305	203 - 410	80	22.6	575	15.0	6.8	2.8	70	1.4	37	X	1/2"	1/2"	70
<b>55 &amp; 75 Series – Lever Start – Non-Reversible</b>																
55NAL-4P-4		28 - 57	38 - 77	480	19.1	486	7.3	3.3	1.6	41	72.0	18	P	1/2"	1/2"	55
55NAL-4T-4		33 - 69	39 - 93	400	19.3	489	7.6	3.5	2.0	50	0.9	22	T	1/2"	1/2"	55
55NAL-3P-4		39 - 84*	49 - 114*	320	19.1	486	7.3	3.3	1.6	41	72.0	18	P	1/2"	1/2"	55
55NAL-3T-4		45 - 100	58 - 136	270	19.3	489	7.6	3.5	2.0	50	0.9	22	T	1/2"	1/2"	55
55NAL-2T-4		55 - 130*	68 - 176*	200	19.3	489	7.6	3.5	2.0	50	0.9	22	T	1/2"	1/2"	55
75NAL-2V-4		100 - 200	135 - 271	210	21.9	556	13.0	5.9	2.5	64	1.1	28	V	1/2"	1/2"	70
	75 NAL-2X-6	160 - 320	215 - 430	130	22.6	575	14.8	6.7	2.8	70	1.4	37	X	1/2"	1/2"	70

\* Maximum torque of tool exceeds the maximum torque rating for the head, high maintenance should be expected when operated at the upper torque capacity range.

**Standard Equipment:**  
Operating instructions & service manual  
Torque Reaction Mounting Plate (75 series)  
All torque springs required to meet indicated torque

**Optional Equipment:**  
Additional accessories: Page 36

**General:**  
Tool performance rated at 90 psi (620kPa) air pressure.

# Angle Nutrunners

19, 24, 34, 45, 55 & 75 Series Stall – Reversible & Non-Reversible

## Cleco®

### 19 Series Reversible

Torque Range:  
3.2 – 6.2 Nm 2.3 – 4.6 Ft. Lbs.

- Lever start
- Sliding knob reverse

### 24 Series Reversible

Torque Range:  
13 Nm 9.6 Ft. Lbs.

- Lever start
- Twist ring reverse

### 34 Series Reversible

Torque Range:  
11 - 36 Nm 8.1 - 26 Ft. Lbs.

- Lever start
- Twist ring reverse

### 45 Series Reversible

Torque Range:  
62 - 125 Nm 46 - 92 Ft. Lbs.

- Button start
- Twist ring reverse

### 55 Series Reversible & Non-Reversible

Torque Range:  
56 - 203 Nm 41 - 150 Ft. Lbs.

- Lever start
- Reversible & non-reversible

### 75 Series Reversible & Non-Reversible

Torque Range:  
210 - 475 Nm 155 - 350 Ft. Lbs.

- Lever start
- Reversible & non-reversible



Model Number	Max. Torque		Square Drive	Free Speed	Length		Weight		Head Height		Side to Center		Air Consumption		
	ft.-lbs.	Nm			in.	RPM	in.	mm	lbs.	kg	in.	mm	in.	mm	Air Inlet NPT

**19 Series – Reversible – Stall**

19RAS03AM2	2.3	3.2	1/4	1700	11.4	290	1.3	0.6	1.06	27	0.36	9	1/8"	3/16"	11
19RAS04AH2	2.6*	3.6*	1/4	1500	11.2	284	1.4	0.6	1.19	30	0.5	13	1/8"	3/16"	11
19RAS05AM2	3.8	5.2	1/4	850	10.6	269	1.2	0.5	1.06	27	0.36	9	1/8"	3/16"	11
19RAS06AH3	4.6	6.2	3/8	880	11.0	279	1.3	0.6	1.19	30	0.5	13	1/8"	3/16"	11

**45 Series – Reversible – Stall**

45RNB-4T-4	46	62	1/2	310	15.1	384	5.5	2.5	2.0	50	0.9	22	3/8"	3/8"	33
45RNB-3P-4	58	79	1/2	250	15.0	381	5.1	2.3	1.6	41	0.7	18	3/8"	3/8"	33
45RNB-3T-4	69	94	1/2	210	15.1	384	5.5	2.5	2.0	50	0.9	22	3/8"	3/8"	33
45RNB-2T-4	92	125	1/2	160	15.1	384	5.5	2.5	2.0	50	0.9	22	3/8"	3/8"	33

**24, 34, 55 & 75 Series – Reversible – Stall**

34RAS11AL3	8.1	11	3/8	1675	12.0	305	2.1	1.0	1.1	28	0.5	12	3/8"	5/16"	34
24RAS13AM3	9.6	13	3/8	1200	11.7	297	2.2	1.0	1.2	30	0.5	13	3/8"	5/16"	24
34RAS28AH3	20	28	3/8	710	12.9	328	2.6	1.2	1.2	31	0.6	14	3/8"	5/16"	34
34RAS36AX3	26	36	3/8	545	13.0	330	2.8	1.3	1.4	35	0.7	17	3/8"	5/16"	34
55RNL-7T-4	41	56	1/2	490	16.1	410	6.1	2.8	2.0	50	0.9	22	1/2"	1/2"	55
55RNL-3T-4	100*	136*	1/2	195	16.8	425	6.5	2.9	2.0	50	0.9	22	1/2"	1/2"	55
55RNL-2T-4	130*	176*	1/2	145	16.8	425	6.5	2.9	2.0	50	0.9	22	1/2"	1/2"	55
75RNL-3V-4	155	210	1/2	190	19.4	492	11.4	5.2	2.5	64	1.1	28	1/2"	1/2"	70
75RNL-3X-6	245	330	3/4	120	20.1	511	13.1	6.0	2.8	70	1.4	37	1/2"	1/2"	70
75RNL-2X-6	325	440	3/4	90	20.1	511	13.1	6.0	2.8	70	1.4	37	1/2"	1/2"	70

\* Maximum torque of tool exceeds the maximum torque rating for the head, increased maintenance should be expected when operated at the upper torque capacity range.

**General:**

Tool performance rated at 90 psi (620kPa) air pressure.

**Standard Equipment:**

Operating instructions & service manual  
Suspension ball (19 series)  
Torque reaction mounting plate (75 series)

**Optional Equipment:**

19 Series: Non-Reverse Kit: 207030  
Overhose: 207019

Quick Change and 1/4" magnetic hex outputs available on AH3 models only.  
Quick Change: Change AH3 to AHQ  
1/4" Magnetic Hex: Change AH3 to AHM  
24/34 Series: Assembly wrench:  
Non-reverse kit  
Additional accessories: Page 36

201898  
204999

Model Number	Max. Torque		Square Drive	Free Speed	Length		Weight		Head Height		Side to Center		Air Consumption		
	ft.-lbs.	Nm			in.	RPM	in.	mm	lbs.	kg	in.	mm	in.	mm	Air Inlet NPT

**55 & 75 Series Non-Reversible – Stall**

55NL-3T-4	110*	149*	1/2	290	16.8	425	6.4	2.9	2.0	50	0.9	22	1/2"	1/2"	55
55NL-2T-4	150*	203*	1/2	210	16.8	425	6.4	2.9	2.0	50	0.9	22	1/2"	1/2"	55
75NL-3V-4	165	225	1/2	300	19.4	492	11.1	5.0	2.5	64	1.1	28	1/2"	1/2"	70
75NL-2V-4	220*	298*	1/2	230	19.4	492	11.1	5.0	2.5	64	1.1	28	1/2"	1/2"	70
75NL-2X-6	350	475	3/4	140	20.1	511	12.9	5.8	2.8	70	1.4	37	1/2"	1/2"	70

\* Maximum torque of tool exceeds the maximum torque rating for the head, high maintenance should be expected when operated at the upper torque capacity range.

**General:**

Tool performance rated at 90 psi (620kPa) air pressure

**Standard Equipment:**

Operating instructions & service manual  
Torque Reaction Mounting Plate (75 series)

**Optional Equipment:**

Additional accessories: Page 36  
Safety Lever: 201638

**19, 24, & 34 Model Number Example**

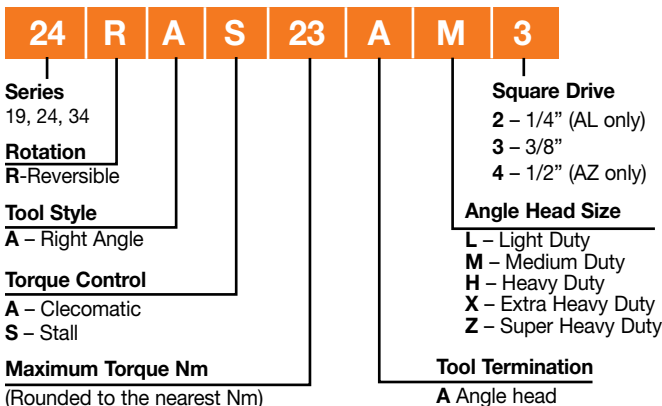

**45, 55 & 75 Model Number Example**

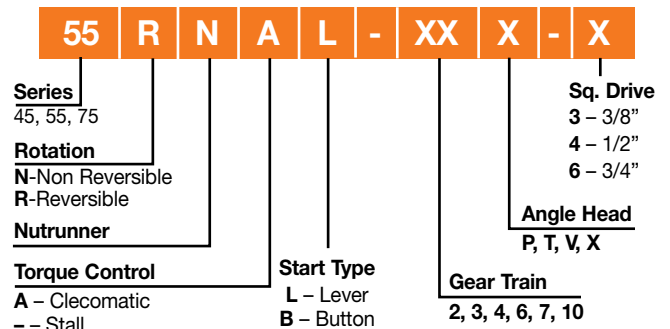



# Swingbar Nutrunners

## Cleco®

### Smaller, Faster, Lighter

For high torque applications where a small tool is necessary, for consistency in clamp load across joint types or for simply eliminating the maintenance needs of an angle tool, the Cleco 64 Series provides the best solution for today's heavy assembly environment.

### Benefits of a Swingbar Tool

A swingbar tool includes a reaction bar that freely swings 360°. This allows the reaction bar to be moved to an appropriate bracing point without any disassembly or repositioning of a spline. Once positioned, the reaction bar absorbs the reaction forces of the tool.

### Selectork

Output torque from a stall tool is achieved by adjusting the air pressure to the tool. If the tool is

moved from location to location or if other tools requiring full line pressure use the same air line, the tool will require a dedicated air pressure regulator.

The Cleco Selectork feature in the 64 Series tools is a small pressure regulator that takes the place of the standard air inlet bushing and eliminates the need to have a separate pressure regulator installed in the plant floor system. Because of the small size of the Selectork there is a limited pressure adjustment range of from 60 to 90 psi. To order this option on the Cleco 64TTS Swingbar tools replace the "S" in the model number with a "K" (64TTS...to a 64TTK...).

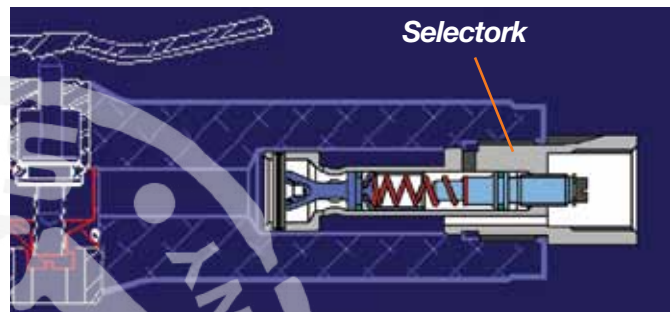

### Reversible

*A simple to use and convenient slide reverse lever improves productivity by allowing for the loosening of fasteners without changing tools.*



### Improved Ergonomics

*Top and bottom air inlets help customize the 64 Series Reaction Bar Nutrunners to the operator's work area.*

### Improved Ergonomics

*Comfort molded handles and lighter weights reduce operator fatigue and improve productivity*

### Selectork

*for optimal in-tool air pressure regulation.*

### Ergonomics

*Infinite-position reaction bar can quickly be moved to an appropriate brace point, eliminating reaction forces of the rundown.*

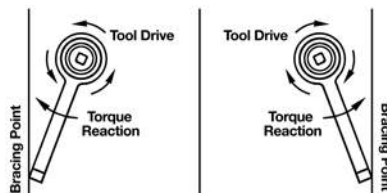

**Torque Bar Opposes Rotation of Tool**



## Speed and Torque Tests for the Cleco 64 Series Swingbar Nutrunners

The goal of any fastening application is to maintain a high degree of accuracy while minimizing the length of time required to perform the rundown. The Cleco 64 Series Swingbar Nutrunners utilize a single powerful motor that limits speed shifts and offers a fast and accurate rundown regardless of joint type.

Competitive units with high RPM's quickly drop their speed at threshold resulting in an overall longer rundown period. This gap is multiplied when prevailing torque is present.

To read the graphs below, the orange line represents the tool speed while the blue line represents the torque generated throughout a rundown. Notice the correlation between speed and torque and its overall effect on rundown time.

*The swingbar can instantly be positioned to absorb the torque reaction of the tool while maintaining a comfortable position with the trigger hand.*

### Random Comparison on 120° Joint

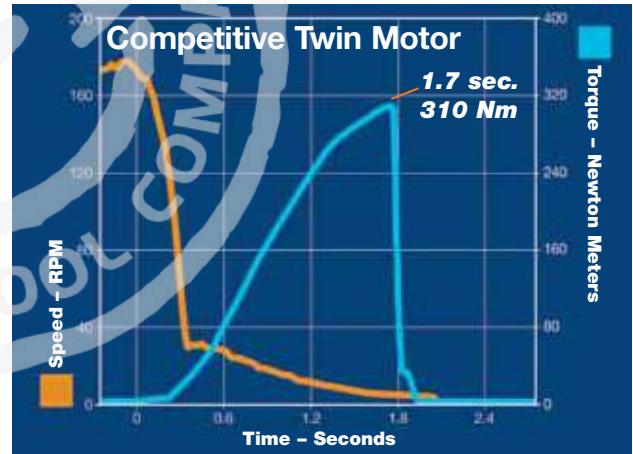
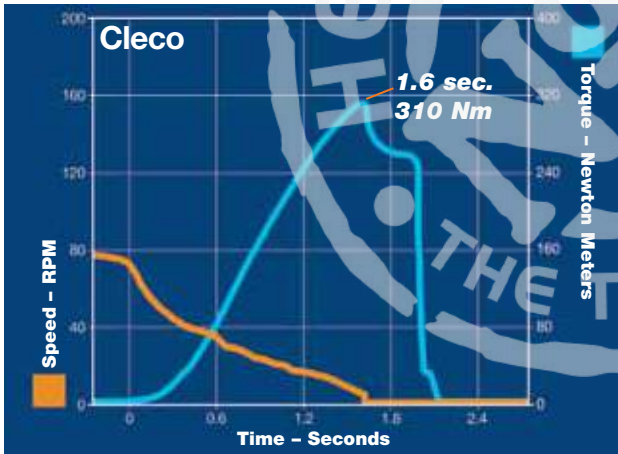

### Random Comparison on 720° Joint

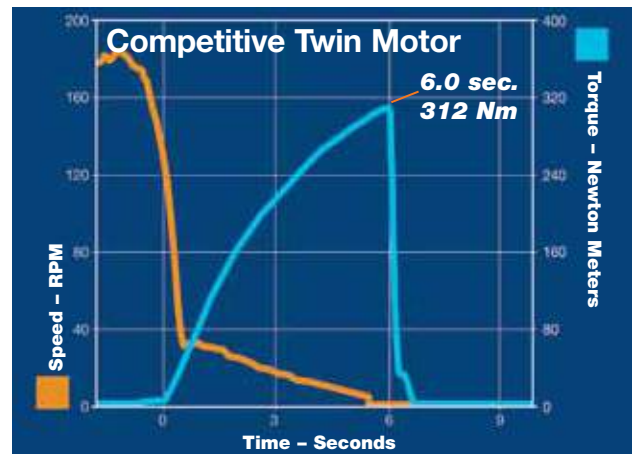
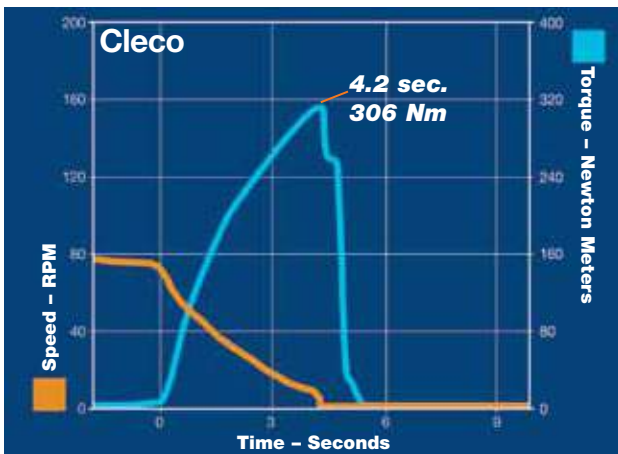

Again the free speed of the Cleco tool is slower, however with its faster tightening speed the overall time is almost 2 seconds faster.

# Reaction Bar & Swingbar Nutrunners

## Cleco®

### 45 Series Inline

**Torque Range:**  
14 - 62 Nm 10 - 46 Ft. Lbs.

- Button start
- Twist ring reverse



### 55 Series Inline

**Torque Range:**  
27 - 91 Nm 20 - 67 Ft. Lbs.

- Lever start
- Twist ring reverse



### 64 Series Pistol

**Torque Range:**  
34 - 3850 Nm 25 - 2837 Ft. Lbs.

- Trigger start
- Sliding knob reverse
- Swingbar



### Selectork 64 Series

**Torque Range:**  
26 - 3850 Nm 19 - 2837 Ft. Lbs.

- Pistol grip
- Reversible
- Swingbar
- Selectork adjustment allows air pressure regulation at the tool for individual performance from a common air line



#### 45 & 55 Model Number Example

**55 R N A L - X - X**

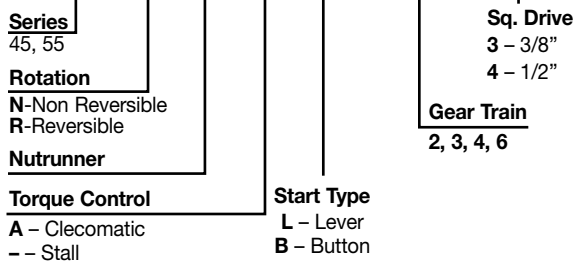

#### 64 Model Number Example

**64 T T S XX D X**

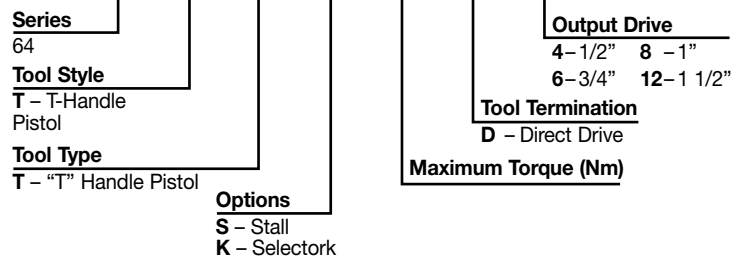

Model Number	Torque Range		Drive Size	Free Speed RPM	Length		Weight*		Air Consumption			
	ft.-lbs.	Nm			in.	mm	lbs.	kg	Air Inlet NPT	Min. Hose I.D.	SCFM	
<b>45 Series – Inline – Clecomatic – Button Start – Twist Ring Reverse</b>												
45RNAB-6-3	10 - 16	14 - 22	3/8	740	14.5	368	5.4	2.4	3/8"	3/8"	33	
45RNAB-4-3	14 - 22	19 - 30	3/8	560	14.5	368	5.4	2.4	3/8"	3/8"	33	
45RNAB-3-3	18 - 33	24 - 45	3/8	370	14.5	368	5.4	2.4	3/8"	3/8"	33	
45RNAB-2-4	23 - 46	31 - 62	1/2	270	14.5	368	5.4	2.4	3/8"	3/8"	33	
<b>55 Series – Inline – Clecomatic – Lever Start – Twist Ring Reverse</b>												
55RNAL-4-4	20 - 34	27 - 46	1/2	560	16.1	410	6.5	3.0	1/2"	1/2"	55	
55RNAL-3-4	25 - 51	34 - 69	1/2	370	16.1	410	6.5	3.0	1/2"	1/2"	55	
55RNAL-2-4	30 - 67	46 - 91	1/2	270	16.1	410	6.5	3.0	1/2"	1/2"	55	

\* Weight without reaction bar.

**General:**

Tool performance rated at 90 psi (620kPa) air pressure

**Standard Equipment:**

Operating instructions & service manual  
Aluminum Torque Reaction Bar

**Optional Equipment:**

Steel Torque Reaction Bar: 869770  
Additional accessories: Page 36

Model Number		Torque Range		Drive Size	Free Speed RPM	Length		Weight*		Air Consumption		
Non-Selectork	Selectork	ft.-lbs.	Nm			in.	mm	lbs.	kg	Air Inlet NPT	Min. Hose I.D.	SCFM
<b>Pistol – Trigger Start – Reversible</b>												
64TTS34D4	64TTK34D4	19 - 25	26 - 34	1/2"	725	11.5	290.8	6.3	2.9	3/8"	1/2"	60
64TTS44D4	64TTK44D4	24 - 32	33 - 44	1/2"	570	11.5	290.8	6.3	2.9	3/8"	1/2"	60
64TTS55D4	64TTK55D4	30 - 41	41 - 55	1/2"	445	11.5	290.8	6.3	2.9	3/8"	1/2"	60
64TTS75D4	64TTK75D4	41 - 55	56 - 75	1/2"	340	11.5	290.8	6.3	2.9	3/8"	1/2"	60
64TTS90D4	64TTK90D4	50 - 66	68 - 90	1/2"	270	11.5	290.8	6.3	2.9	3/8"	1/2"	60
64TTS110D4	64TTK110D4	61 - 81	83 - 110	1/2"	225	11.5	290.8	6.3	2.9	3/8"	1/2"	60
64TTS125D4	64TTK125D4	69 - 92	94 - 125	1/2"	200	11.5	290.8	6.3	2.9	3/8"	1/2"	60
64TTS140D4	64TTK140D4	77 - 103	105 - 140	1/2"	180	11.5	290.8	6.3	2.9	3/8"	1/2"	60
64TTS150D6	64TTK150D6	83 - 111	113 - 150	3/4"	160	12.5	316.2	8.2	3.7	3/8"	1/2"	60
64TTS175D6	64TTK175D6	97 - 129	131 - 175	3/4"	135	12.5	316.2	8.2	3.7	3/8"	1/2"	60
64TTS205D6	64TTK205D6	113 - 151	154 - 205	3/4"	115	12.5	316.2	8.2	3.7	3/8"	1/2"	60
64TTS255D6	64TTK255D6	141 - 188	191 - 255	3/4"	95	12.5	316.2	8.2	3.7	3/8"	1/2"	60
64TTS345D6	64TTK345D6	191 - 254	259 - 345	3/4"	70	12.5	316.2	8.2	3.7	3/8"	1/2"	60
64TTS425D6	64TTK425D6	235 - 313	319 - 425	3/4"	55	12.5	316.2	8.2	3.7	3/8"	1/2"	60
64TTS570D6	64TTK570D6	315 - 420	428 - 570	3/4"	42	13.0	328.9	8.6	3.9	3/8"	1/2"	60
64TTS640D8	64TTK640D8	354 - 472	480 - 640	1"	32	15.9	404.1	14.5	6.6	3/8"	1/2"	60
64TTS750D8	64TTK750D8	415 - 553	563 - 750	1"	27	15.9	404.1	14.5	6.6	3/8"	1/2"	60
64TTS930D8	64TTK930D8	514 - 686	698 - 930	1"	22	15.9	404.1	14.5	6.6	3/8"	1/2"	60
64TTS1260D8	64TTK1260D8	697 - 929	945 - 1260	1"	16	15.9	404.1	14.5	6.6	3/8"	1/2"	60
64TTS1475D8	64TTK1475D8	816 - 1088	1106 - 1475	1"	14	15.9	404.1	14.5	6.6	3/8"	1/2"	60
64TTS1820D8	64TTK1820D8	1007 - 1342	1365 - 1820	1"	11	15.9	404.1	14.5	6.6	3/8"	1/2"	60
64TTS1985D8	64TTK1985D8	1098 - 1464	1489 - 1985	1"	10	15.9	404.1	14.5	6.6	3/8"	1/2"	60
64TTS3850D12	64TTK3850D12	2128 - 2837	2888 - 3850	1 1/2"	5	21.5	546.1	32.2	14.6	3/8"	1/2"	60

\* Weight without reaction bar.

**General:**

Tool performance rated at 90 psi (620kPa) air pressure.

**Standard Equipment:**

Operating instructions & service manual  
Aluminum Torque Reaction Bar  
Steel Torque Reaction Bar (tools rated above 50 ft. lbs.)  
Slave Square Drive (64TTS3850D12 & 64TTK3850D12)

**Optional Equipment:**

Steel Torque Reaction Bar: 64.....D4 series: 48047128  
Additional accessories: Page 36

# Flush Socket Nutrunners

Clecomatic Clutch & StallStall



## 34 Series

**Torque Range:**  
5 – 103 Nm      4 – 76 Ft. Lbs

- External torque adjustment (Clecomatic models)
- Indexable anglehead
- One torque spring to meet specified range
- Oilless blades
- Reversible 



**X Dimension For Flush Socket**

Head	Inches	Millimeters	Socket Size Range
F1	1.54	39	8–15mm
F2	1.69	43	10–15mm
F3	2.32	59	13–21mm

**NOTE:** Models listed are examples. Use chart on bottom of facing page for specific model required but not listed.

Model Number	Free Speed RPM	Torque		Length		Weight		Anglehead				Air Consumption			
		ft.-lbs.	Nm	in.	mm	lbs.	kg	Height in.	mm	Side to Center in.	mm	Air Inlet NPT	Min. Hose I.D.	SCFM	
<b>Clecomatic - Lever Start - Reversible</b>															
34RAA09F1	1825	4-7	5-9	17.0	432	3.7	1.7	1.54	39	0.55	14	3/8"	5/16"	34	
34RAA16F1	1055	7-12	9-16	17.0	432	3.7	1.7	1.54	39	0.55	14	3/8"	5/16"	34	
34RAA28F1	645	10-20*	14-28*	17.8	452	3.9	1.8	1.54	39	0.55	14	3/8"	5/16"	34	
34RAA33F2	540	12-24	17-33	18.8	478	4.7	2.1	1.69	43	0.67	17	3/8"	5/16"	34	
34RAA47F2	380	17-35	24-47	19.0	483	5.1	2.3	1.69	43	0.67	17	3/8"	5/16"	34	
34RAA53F2	265	17-39	24-53	19.0	483	5.1	2.3	1.69	43	0.67	17	3/8"	5/16"	34	
34RAA67F3	265	24-49	33-67	20.5	521	5.8	2.6	2.32	59	0.87	22	3/8"	5/16"	34	
34RAA94F3	185	35-69	47-94	20.5	521	5.8	2.6	2.32	59	0.87	22	3/8"	5/16"	34	
<b>Stall - Lever Start - Reversible</b>															
34RAS10F1	1825	7	10	17.0	432	3.4	1.5	1.54	39	0.55	14	3/8"	5/16"	34	
34RAS18F1	1055	13	18	17.0	432	3.4	1.5	1.54	39	0.55	14	3/8"	5/16"	34	
34RAS30F1	645	22*	30*	17.8	452	3.5	1.6	1.54	39	0.55	14	3/8"	5/16"	34	
34RAS40F2	480	29	40	19.0	483	4.4	2.0	1.69	43	0.67	17	3/8"	5/16"	34	
34RAS52F2	380	38	52	19.0	483	4.4	2.0	1.69	43	0.67	17	3/8"	5/16"	34	
34RAS58F3	335	43	58	20.5	521	5.5	2.5	2.32	59	0.87	22	3/8"	5/16"	34	
34RAS73F3	265	54	73	20.5	521	5.5	2.5	2.32	59	0.87	22	3/8"	5/16"	34	
34RAS103F3	185	76	103	20.5	521	5.5	2.5	2.32	59	0.87	22	3/8"	5/16"	34	

\* Maximum torque of tool exceeds the maximum torque rating for the head, high maintenance should be expected when operated at the upper torque capacity range.

**General:**  
Tool performance rated at 90 psi (620kPa) air pressure.

**Standard Equipment:**  
Operating instructions & service manual  
Suspension ball  
Exhaust Overhose  
Clutch adjustment tool (Clecomatic tools)  
Mounting plate (F3 tools)

**Optional Equipment:**  
Assembly wrench: 201898  
Torque signal kit: 301937PT  
Non-reversible kit: 204999  
Mounting plates: F1 tools 57217101      57218103  
F2 tools 43287131  
Additional accessories: Page 36



Tight clearance applications, once only accessible by the use of hand tools or crowfoot attachments, can now be tightened by the family of Cleco Flush Socket Pneumatic Tools at a speed that maximizes productivity. Tools equipped with a Clecomatic clutch assure good torque repeatability.

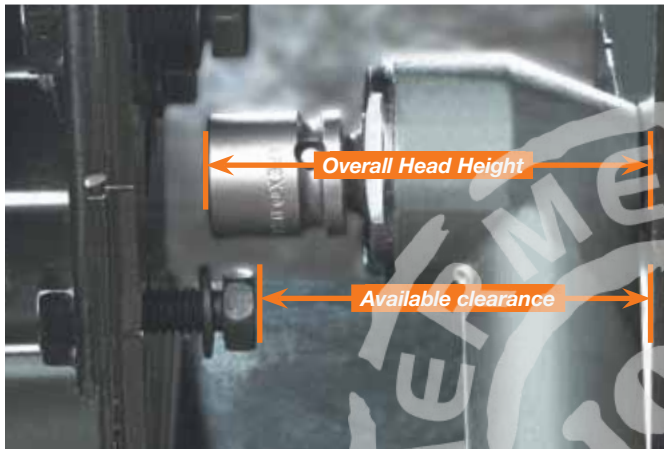

**Standard right angle head with square drive and separate socket will not fit on tight clearance applications. The overall head height is greater than the available clearance.**



**Flush socket tools have plenty of clearance to fit on the same application. Clecomatic flush socket tools tighten with much higher accuracy than tools with crowfoot attachment. The overall head height is less than the available clearance.**

## Model Number Example

### Base Tool

**34 R A A 16 F1**

#### Motor

#### Reversible

#### Tool Style

A - Angle

#### Control

A - Clutch  
S - Stall

#### Maximum Torque Output

**F1** Clutch: 9, 16, 28 Nm  
Stall: 10, 18, 30 Nm

**F2** Clutch: 33, 47, 53 Nm  
Stall: 40, 52 Nm

**F3** Clutch: 67, 94 Nm  
Stall: 58, 73, 103 Nm

#### Flush Socket Head

**F1 Head:** 8-15 mm socket capacity  
**F2 Head:** 10-15 mm socket capacity  
**F3 Head:** 13-21 mm socket capacity

### Socket No. (ordered with base tool)

**FS 1 MG 0 0**

#### Flush Socket Head

1 - F1 Head  
2 - F2 Head  
3 - F3 Head

#### Socket Type

FS - Flush

#### Output Type

1-Thru Hex 2-Magnetic

#### Extension Length

0 - Flush 2 - 1/4" 4 - 1/2" 6 - 3/4"

#### Socket Sizes

<b>EC</b> - 3/8"	<b>MA</b> - 7mm
<b>ED</b> - 7/16"	<b>MB</b> - 8mm
<b>EE</b> - 1/2"	<b>MC</b> - 9mm
<b>EF</b> - 9/16"	<b>MD</b> - 10mm
	<b>ME</b> - 11mm
	<b>MF</b> - 12mm
	<b>MG</b> - 13mm
	<b>MH</b> - 14mm
	<b>MI</b> - 15mm
	<b>MM</b> - 19mm

**Note:** When ordering, specify the base tool and order the socket separately. The socket will be installed in the tool before shipment.

# Crowfoot Nutrunners

Clecomatic Clutch & Stall

# Cleco®

## 34 Series

**Torque Range:**  
 14 – 30 Nm      10 – 22 Ft. Lbs

- External torque adjustment (Clecomatic models)
- Indexable anglehead
- One torque spring to meet specified range
- Oilless blades
- Reversible 



**NOTE:** Models listed are examples. Use chart on bottom of facing page for specific model required but not listed.

Model Number		Free Speed	Torque Range		Socket Size		Length		Weight		Air Consumption		
15 Degree Head	30 Degree Head	RPM	ft.-lbs.	Nm	in.	mm	in.	mm	lbs.	kg	NPT	I.D.	SCFM
<b>Clecomatic - Lever Start - Reversible</b>													
34RCA30D1	34RCA30D3	425	11-22	15-30	5/16	8	20.0	507	4.7	2.2	3/8"	5/16"	34
<b>Stall - Lever Start - Reversible</b>													
34RCS29D1	34RCS29D3	490	21	29	5/16	8	19.6	497	4.5	2.1	3/8"	5/16"	34

**General:**  
 Tool performance rated at 90 psi (620kPa) air pressure.

**Standard Equipment:**  
 Operating instructions & service manual  
 Suspension bail  
 Exhaust Overhose  
 Clutch adjustment tool (Clecomatic tools)

**Extra Equipment:**  
 Specify socket from page 31

**Optional Equipment:**  
 Assembly wrench: 201898  
 Torque signal kit: 301937PT  
 Non-reversible kit: 204999  
 Additional accessories: Page 36

### 15° Head

Part Number: 301071  
 Maximum Recommended  
 Torque: 22 ft. lbs. (30 Nm)  
 Standard Length Socket

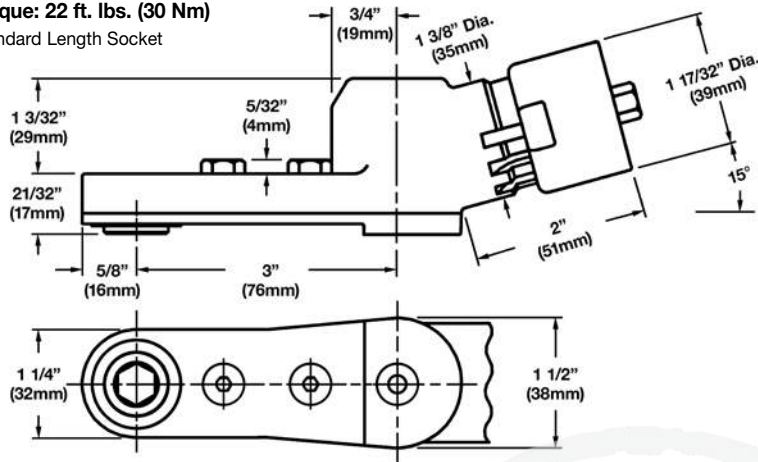

### 30° Head

Part Number: 301072  
 Maximum Recommended  
 Torque: 22 ft. lbs. (30 Nm)  
 Standard Length Socket

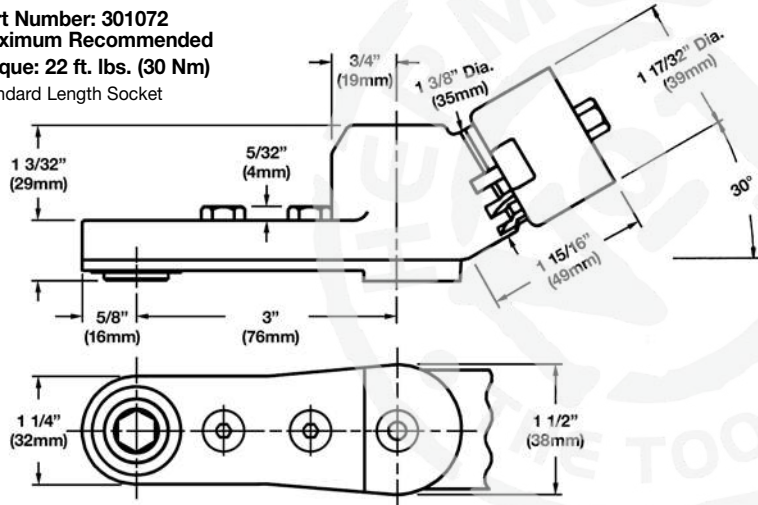

### Model Number Example

#### Base Tool

**34** | **R** | **C** | **A** | **30** | **D1**

**Motor**  
34

**Rotation**  
R - Reversible

**Tool Style**  
C - Crowfoot

#### Control

A - Clecomatic  
 S - Stall

#### Max Output Torque

Clecomatic: 30  
 Stall: 14, 29

#### Tool Termination

D1 15° Head  
 D3 30° Head

#### Socket No. (ordered with base tool)

**CS** | **XX** | **X** | **X**

**Crowfoot Socket**

#### Output Type

1 - Thru Hex

#### Extension Length

0 - Flush    4 - 1/2"    6 - 3/4"

#### Sockets

Flush		1/2" Extended	3/4" Extended
EA - 1/4"	MD - 10mm	EB - 5/16"	EE - 1/2"
EC - 3/8"	ME - 11mm	EC - 3/8"	MG - 13mm
ED - 7/16"	MF - 12mm	ED - 7/16"	MH - 14mm
EE - 1/2"	MG - 13mm	EE - 1/2"	
EF - 9/16"	MH - 14mm	EF - 9/16"	
EB - 5/16"	MI - 15mm	MB - 8mm	
EC - 3/8"		MD - 10mm	
ED - 7/16"		ME - 11mm	
EE - 1/2"		MF - 12mm	
EF - 9/16"		MG - 13mm	



# Hold & Drive Nutrunners

Clecomatic Clutch & Stall

# Cleco®

## 34 Series

**Torque Range:**  
24 – 103 Nm      17 – 76 Ft. Lbs

- External torque adjustment (Clecomatic models)
- Indexable anglehead
- One torque spring to meet specified range
- 1" retraction of hold spindle
- Oilless blades
- Reversible 

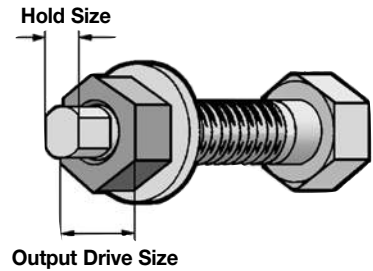

**NOTE:** Models listed are examples. Use chart on bottom of facing page for specific model required but not listed.

Model Number	Hold Size	Free Speed RPM	Torque		Length		Weight		Anglehead				Air Consumption		
			ft.-lbs.	Nm	in.	mm	lbs.	kg	Height		Side to Center		NPT	Hose I.D.	SCFM
									in.	mm	in.	mm			
<b>Clecomatic - Lever Start - Reversible</b>															
34RAA53H3	5mm Female Hex	335	17-39	24-53	20.7	526	8.0	3.5	2.4	61	1.06	27	3/8"	5/16"	34
34RAA67H3	7mm Female Hex	265	24-49	33-67	20.7	526	8.0	3.5	2.4	61	1.06	27	3/8"	5/16"	34
34RAA94H3	8mm Female Hex	185	35-69	47-94	20.7	526	8.0	3.5	2.4	61	1.06	27	3/8"	5/16"	34
<b>Stall - Lever Start - Reversible</b>															
34RAS58H3	5mm Female Hex	335	43	58	20.7	526	7.7	3.5	2.4	61	1.06	27	3/8"	5/16"	34
34RAS73H3	T30 Torx	265	54	73	20.7	526	7.7	3.5	2.4	61	1.06	27	3/8"	5/16"	34
34RAS103H3	10mm Female Hex	185	76	103	20.7	526	7.7	3.5	2.4	61	1.06	27	3/8"	5/16"	34

**General:**

Tool performance rated at 90 psi (620kPa) air pressure.

**Standard Equipment:**

Operating instructions & service manual  
Suspension bail  
Exhaust Overhose  
Clutch adjustment tool (Clecomatic tools)  
Mounting Plate

**Optional Equipment:**

Assembly wrench: 201898  
Torque signal kit: 301937PT  
Non-reversible kit: 204999  
Additional accessories: Page 36

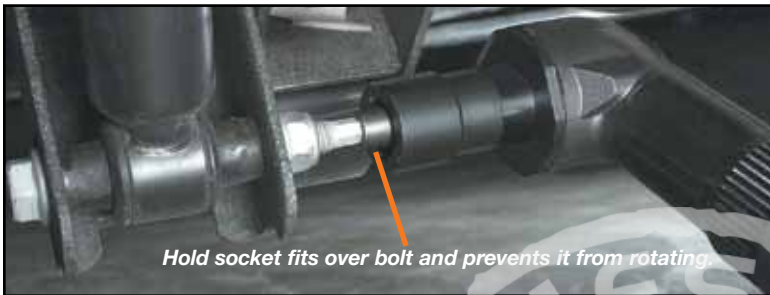

“Hold & Drive” bolts are used with these tools in automotive and truck frame applications. They reduce assembly handling to one person working from one side of the workpiece. The bolt is held stationary by the tool while the nut is tightened from the same side.

### Model Number Example

Base Tool						Drive Socket			Hold Socket		
<b>34</b>	<b>R</b>	<b>A</b>	<b>A</b>	<b>53</b>	<b>H</b>	<b>H3</b>	<b>ML</b>	<b>O</b>	<b>M6</b>	<b>B</b>	
<b>Motor</b>	<b>Reversible</b>										<b>Oval Length (for oval only)</b>
	<b>Tool Style</b>										<i>(Example: For a 6mm x 8mm oval, this dimension would be MB, but drop the "M" as in M6B.)</i>
	<b>A - Angle</b>										<b>Hold Socket (dimension across flats, oval also)</b>
<b>Control</b>											<b>EA - 1/4"</b>
<b>A - Clutch</b>											<b>M6 - 6mm</b>
<b>S - Stall</b>											<b>MH - 14mm</b>
<b>Maximum Torque Output</b>											<b>EB - 5/16"</b>
Clutch: 53, 67, 94 Nm											<b>MA - 7mm</b>
Stall: 58, 73, 103 Nm											<b>15 - T15</b>
<b>Tool Termination</b>											<b>EC - 3/8"</b>
<b>H - Hold &amp; Drive</b>											<b>MB - 8mm</b>
											<b>20 - T20</b>
											<b>ED - 7/16"</b>
											<b>MC - 9mm</b>
											<b>25 - T25</b>
											<b>EE - 1/2"</b>
											<b>MD - 10mm</b>
											<b>30 - T30</b>
											<b>EF - 9/16"</b>
											<b>ME - 11mm</b>
											<b>40 - T40</b>
											<b>EG - 5/8"</b>
											<b>MF - 12mm</b>
											<b>45 - T45</b>
											<b>M5 - 5mm</b>
											<b>MG - 13mm</b>
											<i>(Example: On a 6mm x 8mm oval, this dimension would be M6.)</i>
											<b>Hold Socket Style</b>
											<b>F - Female Hex</b>
											<b>T - Torx</b>
											<b>M - Male Hex</b>
											<b>O - Female oval</b>
											<b>Retainer Shaft Length</b>
											<b>3 - 3 1/2"</b>
											<b>4 - 4"</b>
											<b>5 - 5 3/8"</b>
											<b>6 - 5 7/8"</b>
											<b>9 - 9"</b>
											<b>Drive Socket Size</b>
											<b>EE - 1/2"</b>
											<b>EK - 7/8"</b>
											<b>EQ - 1 1/4"</b>
											<b>MG - 13mm</b>
											<b>MM - 19mm</b>
											<b>MS - 25mm</b>
											<b>EF - 9/16"</b>
											<b>EL - 15/16"</b>
											<b>MH - 14mm</b>
											<b>MN - 20mm</b>
											<b>MT - 26mm</b>
											<b>EG - 5/8"</b>
											<b>EM - 1"</b>
											<b>MI - 15mm</b>
											<b>MO - 21mm</b>
											<b>MU - 27mm</b>
											<b>EH - 11/16"</b>
											<b>EN - 1 1/16"</b>
											<b>EI - 3/4"</b>
											<b>EJ - 13/16"</b>
											<b>EO - 1 1/8"</b>
											<b>EJ - 13/16"</b>
											<b>EP - 1 3/16"</b>
											<b>MJ - 16mm</b>
											<b>MP - 22mm</b>
											<b>MX - Special</b>
											<b>MK - 17mm</b>
											<b>MQ - 23mm</b>

Note: When ordering, specify the base tool and order the socket separately. The socket will be installed in the tool before shipment.

# Tube Nut Wrenches

Clecomatic Clutch

## Cleco®

### 24 Series

**Torque Range:**  
14 - 40 Nm  
19 - 54 Ft. Lbs

- One hand, two position throttle
- External torque adjustment
- Auto alignment socket



24 Series (T2)

24 Series (T3)

24 Series (T4)

24 Series Power Unit  
With Auto Alignment

### Termination

#### T2, T3 & T4 Head Height

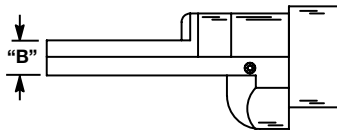

#### T2 Head

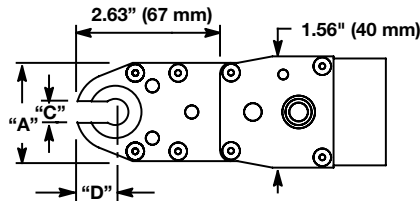

#### T3 Head

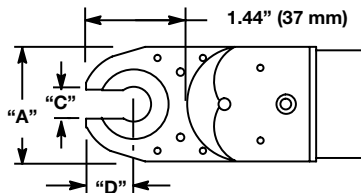

#### T4 Head

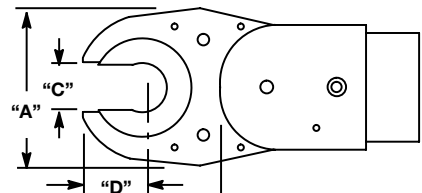

**NOTE:** Models listed are examples. Use chart on bottom of facing page for specific model required but not listed.

Model Number	Free Speed RPM	Torque Range		Weight		Length		Socket Size		"A"		"B"		"C"*		"D"	
		Ft. Lbs.	Nm	lbs.	kg	in.	mm	in.	mm	in.	mm	in.	mm	in.	mm	in.	mm
<b>Power Unit Only</b>																	
24RTA12	670	3.6 - 8.9	5 - 12	2.7	1.2	12	305	NA	NA	NA	NA	NA	NA	NA	NA	NA	NA
<b>Self Aligning</b>																	
24RTA20T2	240	10.4 - 14.7	14 - 20	4.3	2.0	16.8	426	7/16	—	1.42	36	0.55	14	0.28	7.0	0.53	13.5
24RTA30T3	175	14.7 - 22.1	20 - 30	4.5	2.0	16.7	426	9/16	—	1.65	42	0.59	15	0.47	11.9	0.73	18.5
24RTA40T4	130	19.2 - 29.5	26 - 40	5.1	2.3	17.7	449	7/8	—	2.36	60	0.59	15	0.67	17.0	0.93	23.5

\* Varies by socket dimension.

#### General:

Air Inlet: 1/4" NPT

Tool performance rated at 90 psi (620kPa) air pressure.

#### Extra Equipment:

Specify socket from page 35

#### Optional Equipment:

Torque signal kit: 301937PT (see page 39)



## Auto Alignment Head

Tube and hose applications, once only accessible by the use of hand tools, can now be tightened by the Cleco family of Tube Nut Wrenches at a speed that maximizes productivity.

Torque repeatability is assured by the proven Clecomatic clutch and low inertia motor. These models use a single lever for the tightening of the fastener and the return of the socket to the open position. The flexibility coupled with the proven capabilities greatly increases the productivity rate of the assembly line.



*Make sure that the socket is set to the open position. If not, push the throttle lever down half way to release the socket back to the open position.*



*Slide the tool on the fastener and push the throttle lever down fully to run the fastener down.*



*To free the tool, slide the tool off the tightened fastener and operate the throttle lever halfway to release the socket back to the open position.*

## Model Number Example

### Base Tool

24 R T A 20 T2

#### Motor

24

#### Tool Style

R – Reversing mechanism for socket orientation

#### Tool Type

T – Tube Nut

#### Torque Control

A – Clecomatic Clutch

#### Max Torque (Nm)

T2 - 20 Nm

T3 - 30 Nm

T4 - 40 Nm

#### Head Size

T2 - 20 Nm Max.

T3 - 30 Nm Max.

T4 - 40 Nm Max.

### Socket (Order Separately)

KS2 ED 0 0

#### Head Type

KS2 - T2

KS3 - T3

KS4 - T4

#### Output Type

0 Partial Thru Hex 2 Double Thru Hex  
1 Thru Hex 3 Partial Thru Double Hex

#### Extension Length

0 Flush 4 1/2"

2 1/4" 6 3/4"

#### Maximum Hex Socket Sizes

MG, 1/2" T2 Head Type

MM, 3/4" T3 Head Type

MU, 1 1/16" T4 Head Type

00, ## (specials) T3 Head Type

#### Socket Sizes

EA - 1/4"

EC - 3/8"

ED - 7/16"

EE - 1/2"

EF - 9/16"

EH - 11/16"

EJ - 13/16"

EK - 7/8"

EL - 15/16"

EM - 1"

EO - 1 1/8"

M5 - 5mm

M6 - 6mm

MA - 7mm

MB - 8mm

MD - 10mm

ME - 11mm

MF - 12mm

MG - 13mm

MH - 14mm

MI - 15mm

MJ - 16mm (5/8")

MK - 17mm

ML - 18mm

MM - 19mm

MN - 20mm

MO - 21mm

MP - 22mm

MQ - 23mm

MR - 24mm

MS - 25mm

MT - 26mm

MU - 27mm (1 1/16")

**Note:** When ordering, specify the base tool and order the socket separately. The socket will be installed in the tool before shipment.

# Nutrunner Accessories

## Torque Reaction Bars & Slave Square Drives

Part No.	Description	Used On
869770	Steel Bar	45, 55 series inline
48047128	Steel Bar	64...D4 series
46037081	Slave Square Drive	64...D4 series
46177030	Slave Square Drive	64...D6 series
46607058	Slave Square Drive	64...D8 series

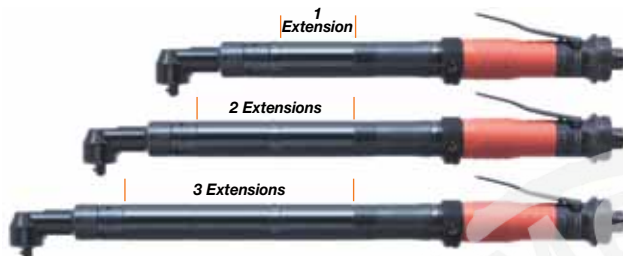

### Extension Kit (3.5")

Part No.	Used On
301081	34 series (37 Nm or higher)
301108	24/34 series (36 Nm or lower)

## Mounting Brackets (right angle tools)

Part No.	Description	Used On
201012	Torque reaction bracket	45, 55 series
201039	Fixed tooling bracket	45, 55 series
201510	Torque reaction bracket	75 series
201034	Torque reaction bracket	75 series (standard)

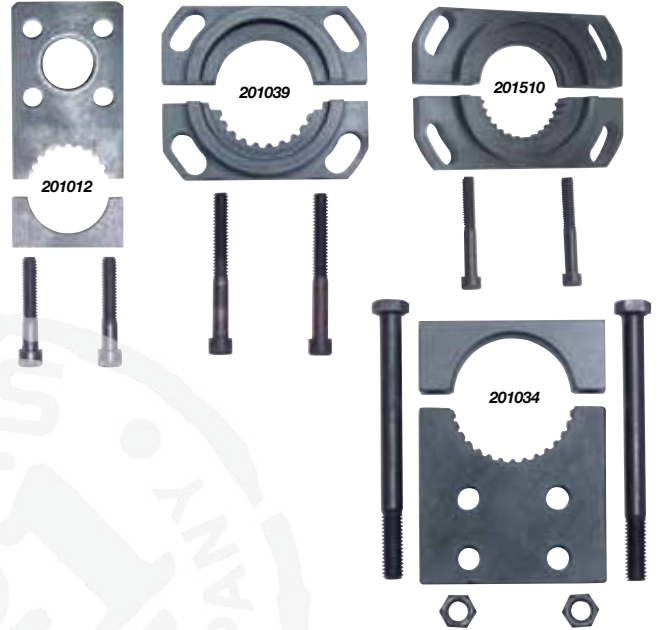

## Anglehead Covers

Part No.	Used On	
	Tool Series	Anglehead
205831	24/34	AH, AM
205833	24/34	AX
205834	24/34	AZ
205837	19	AH
205839	45/55	T
205835	45/55	P
205838	75	V



## Suspension Bail

Part No.	Used On
867711	8, 35, 45, 55 series
204987	24, 34 wire bail



## Swivel Suspension Bail

Part No.	Used On
541715-5	24, 34 series
54397004	64...D4 series
46437006	64...D6 series
46607016	64...D8 series
46037036	64...D12 series



## Torque Signal Kit

Air signal to indicate clutch shut-off.

Part No.	Used On
201900	24/34 Clecomatic (old style)
301937PT	24/34 Clecomatic (new style)
301106	14 Clecomatic



## Assembly Wrench

Part No.	Used On
201898	Two required



## Joint Simulator

Description	Torque Range		Width		Height		Length		Part No.
	ft.-lbs.	Nm	in.	mm	in.	mm	in.	mm	
Joint Simulator	220-12	300-15	10.4	264	16	406	26	667	550006

550006

## Cleco®

### The TVP-100 Series Torque Verifier provides low-cost assembly assurance for pneumatic screwdrivers, nutrunners and pulse tools.

The Cleco TVP-100 verifier improves your assembly process by eliminating operator error caused by early trigger release, fastener cross-threading or re-hits.

The TVP-100 is designed for use with pneumatic clutch screwdrivers/nutrunners and Cleco shut-off pulse tools equipped with torque signal kits.

The TVP-100 provides visual and audio feedback

for both individual fastener and batch parameters, assuring that every fastener has been rundown to the capability of the tool.

Based on existing Cleco TME controller technology, the TVP-100 navigational screen allows for simple set-up and operation.

The TVP-100 works by reading the signature of a ported pneumatic assembly tool through its fastening cycle. Any deviation from the normal signature caused by re-hits, cross threads, early trigger release or a number of variables will elicit a **NOK** visual and audio signal from the verifier, notifying the operator of an error. Whereas a Cleco DC controller controls the tool and the fastening process, the TVP-100 is a cost-effective way of verifying torque by following the torque signature of a tool.



# Accessories

Cleco TVP-100 Series Torque Verifier

## Features

- Verifies fastener installation with **OK/NOK** audio and visual indicators
- On screen verification of individual fastener assembly status with batch count
- VGA screen displays graph for each rundown
- Stores 1,000 rundowns
- Sequencing capability
- 8 parameter sets available for multiple applications
- "Auto Cal" permits fast and easy tool set up for any joint type
- Password protected
- Multiple languages



## TVP-100 Series Torque Verifiers

Model Number		Language	Weight		Width		Height		Depth	
115VAC*	230VAC*		lbs.	kg	in.	mm	in.	mm	in.	mm
TVP-110-15-U	TVP-110-30-U	English	6	2.72	8.75	222	9.13	232	4.13	105
TVP-110-15-D	TVP-110-30-D	German	6	2.72	8.75	222	9.13	232	4.13	105
TVP-110-15-S	TVP-110-30-S	Spanish	6	2.72	8.75	222	9.13	232	4.13	105
TVP-110-15-P	TVP-110-30-P	Portuguese	6	2.72	8.75	222	9.13	232	4.13	105

\*\* 230V units are CE compliant.

All model numbers include power cable, air signal transducer, 25 foot cable to connect TVP to air signal transducer, and 8 foot air line to connect transducer to tool.  
**NOTE:** Tool must be equipped with torque signal kit.

24 Volt Inputs/Outputs:

Inputs: Up to 8 Applications  
 Reset  
 Suspend

Outputs: Cycle Accept  
 Batch Accept  
 Reject

## Accessories

### Torque Signal Kits

Part No.	Tool Used On
301106	19SCA & 19RAA series
302021PT	19TTA & 19PTA series
201900	24RAA and 34RAA <i>(old style)</i>
301937PT	24RAA and 34RAA <i>(new style)</i>
934918	PTH series pulse tools <i>("C" &amp; "D" vintage only)</i>

### Phoenix Connector

Part No.	Description
542892	24 Volt Input/Output Phoenix connector
939348	Strain relief for above connector

### Cables

Part No.	Description
207237	115V Transducer and cable
207238	230V Transducer and cable

*\*115V and 230V transducer and cable assemblies have different connectors at the TVP end of the cable.*





## Cleco Ratchet Wrenches. For Applications That Are “Impossible” To Get To.

### Extensive variety of ratchet heads.

Miniature, bent left, bent right, extended, thin and extra thin ratchet heads are just some examples of the variety of heads available to ensure that you can gain access to the hardest to reach fasteners...even fasteners that can't be seen can be tightened with precision.

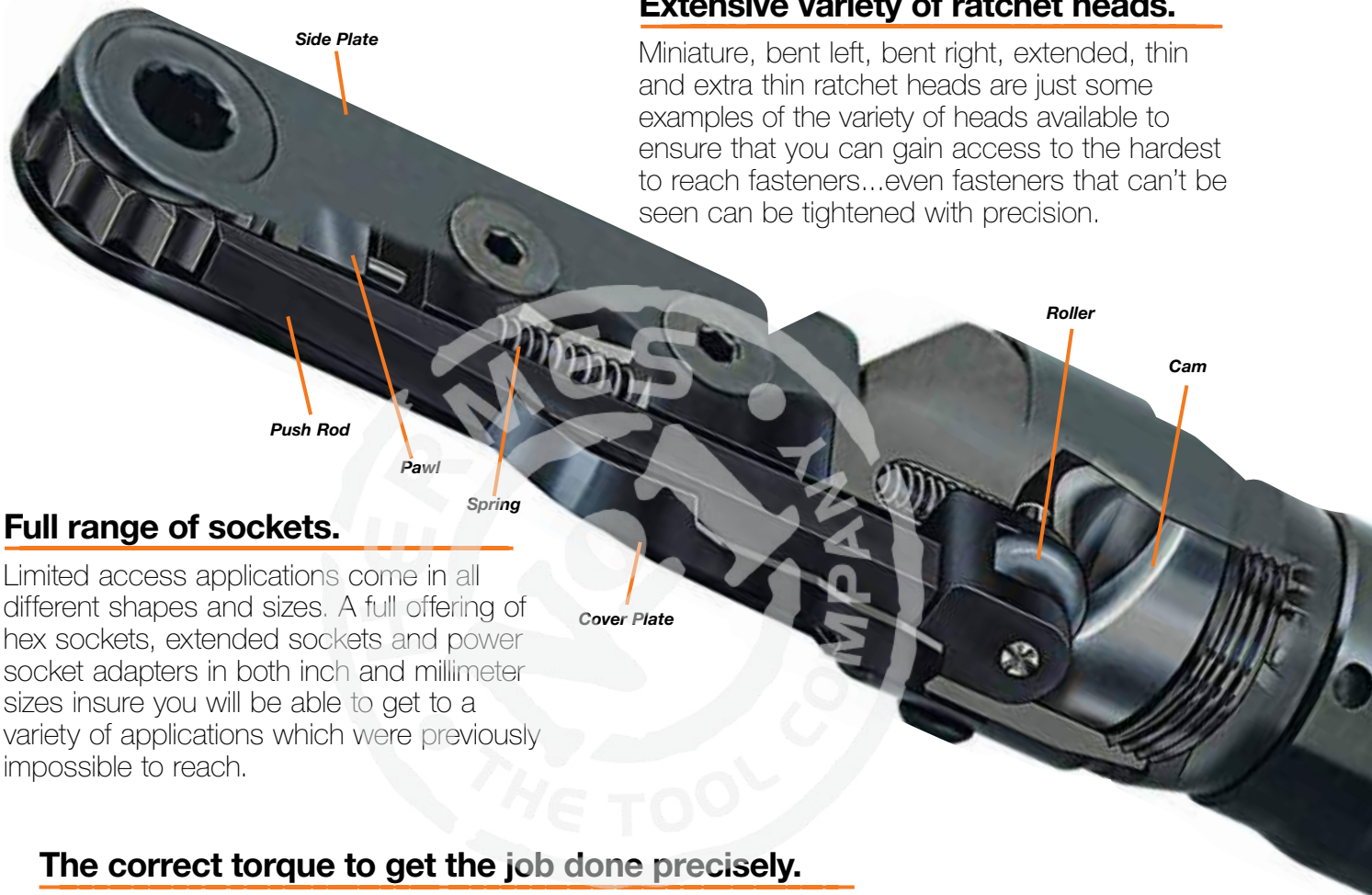

### Full range of sockets.

Limited access applications come in all different shapes and sizes. A full offering of hex sockets, extended sockets and power socket adapters in both inch and millimeter sizes insure you will be able to get to a variety of applications which were previously impossible to reach.

### The correct torque to get the job done precisely.

Cleco 24 and 34 series ratchet wrenches are available in sizes up to 50 Ft.Lbs. Several sizes of side plate widths and thicknesses are available to provide a wide range of torques without sacrificing size or durability.

### Success in simplicity.

By using a single direction stall motor the Cleco 24 and 34 series ratchet wrenches eliminate components that traditionally add cost and decrease service life. With this tool you truly get what you pay for. A very economical and dependable solution for the hardest to reach fasteners. Need a reversible tool? No problem, simply flip the tool over.

## **Gears that have stood up to the test of time.**

The key wear items in the ratchet head (gears, cams, and push rods) have remained unchanged from the previous H16 and H30 tools. Not only can you have confidence in their durability, you won't have to buy new replacement parts.



## **Improved motor for better performance.**

Innovative low inertia motor design provides more usable power in a smaller package size. The end result is a more ergonomic handle for a more productive tool. The same successful motor is used on Cleco flush socket, crowfoot, hold-and-drive and standard Clecomatic clutch shut-off nutrunners.

## **Ergonomic grip for operator comfort.**

Rubber coated motor housing helps isolate the operator from temperature changes.



*Easy assembly/disassembly with a standard spanner wrench.*

*Hardened steel bearing plates resist wear and assures longer life.*

**Cleco®**

# Ratchet Wrenches

Stall Type

## Cleco®

### 24 & 34 Series

**Torque Range:**  
up to 68.3 Nm  
up to 50.4 Ft. Lbs

- Stall type
- Non-Reversible



### Cleco 24/34 Series Model Number Nomenclature

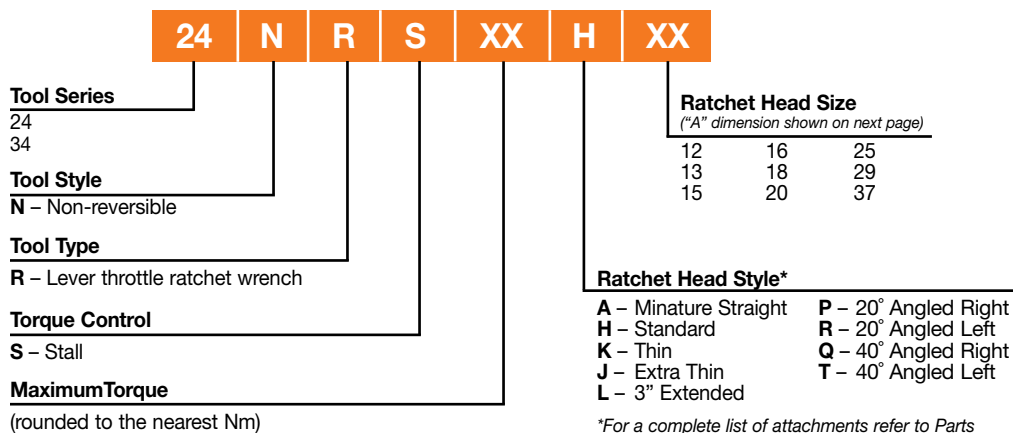

\*For a complete list of attachments refer to Parts Manual #PL17-RA

# Ratchet Wrenches

Stall Type

Cleco®

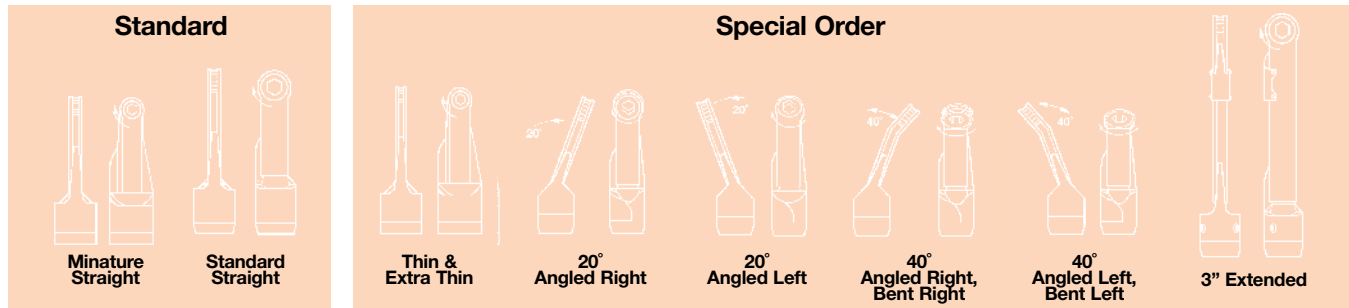

Other head types are available. Contact your Cooper Power Tools sales representative.

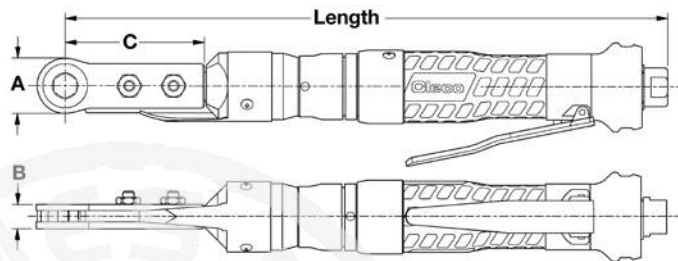

Model Number	Free Speed		Maximum Torque		Maximum Socket Size		"A"		"B"		"C"		Length		Weight	
	RPM	Ft. Lbs.	Nm	in.	mm	in.	mm	in.	mm	in.	mm	in.	mm	lbs.	kg	
<b>24 Series</b>																
24NRS15A13	265	11.0	14.9	7/16	11	13/16	20.6	1/2	12.7	2.88	73.2	13.4	340	2.7	1.2	
24NRS15A12	285	11.1	15.0	3/8	10	3/4	19.0	1/2	12.7	2.88	73.2	13.4	340	2.7	1.2	
24NRS20H15	305	14.8	20.1	1/2	13	15/16	23.8	9/16	14.2	3.13	79.5	14.0	356	2.9	1.3	
24NRS21H16	285	15.4	20.9	9/16	16	1	25.4	9/16	14.2	3.13	79.5	14.0	356	3.0	1.3	
24NRS23A13	145	17.2	23.3	7/16	11	13/16	20.6	1/2	12.7	2.88	73.2	14.2	361	2.9	1.3	
24NRS23H15	170	17.3	23.5	1/2	13	15/16	23.8	9/16	14.2	3.13	79.5	14.8	376	3.1	1.4	
24NRS23H20	250	17.5	23.7	3/4	19	1 1/4	31.8	9/16	14.2	3.13	79.5	14.2	361	3.0	1.4	
24NRS24H16	155	17.7	24.0	9/16	16	1	25.4	9/16	14.2	3.13	79.5	14.8	376	3.2	1.4	
24NRS24H18	265	18.0	24.4	5/8	16	1 1/8	28.6	9/16	14.2	3.13	79.5	14.1	358	3.0	1.4	
24NRS24A12	155	18.3	24.8	3/8	10	3/4	19.0	1/2	12.7	2.88	73.2	14.2	361	2.9	1.3	
24NRS29H18	145	21.4	29.0	5/8	16	1 1/8	28.6	9/16	14.2	3.13	79.5	14.9	378	3.2	1.5	
24NRS29H25	180	21.5	29.1	15/16	24	1 9/16	39.7	9/16	14.2	3.25	82.5	14.4	366	3.1	1.4	
24NRS30H20	135	22.0	29.8	3/4	19	1 1/4	31.8	9/16	14.2	3.13	79.5	14.9	378	3.2	1.5	
<b>34 Series</b>																
34NRS29H15	255	21.6	29.3	1/2	13	15/16	23.8	9/16	14.2	3.13	79.5	16.0	406	3.7	1.7	
34NRS31H16	240	22.9	31.0	9/16	16	1	25.4	9/16	14.2	3.13	79.5	16.0	406	3.7	1.7	
34NRS35H20	210	25.9	35.1	3/4	19	1 1/4	31.8	9/16	14.2	3.13	79.5	16.2	411	3.7	1.7	
34NRS36H18	225	26.7	36.2	5/8	16	1 1/8	28.6	9/16	14.2	3.13	79.5	16.1	409	3.7	1.7	
34NRS36H15	155	26.8	36.3	1/2	13	15/16	23.8	9/16	14.2	3.13	79.5	16.8	427	3.9	1.8	
34NRS38H16	145	28.1	38.1	9/16	16	1	25.4	9/16	14.2	3.13	79.5	16.8	427	3.9	1.8	
34NRS42H25	150	30.9	41.9	15/16	24	1 9/16	39.7	9/16	14.2	3.25	82.5	16.4	417	3.8	1.7	
34NRS46H20	125	33.9	46.0	3/4	19	1 1/4	31.8	9/16	14.2	3.13	79.5	17.0	432	4.0	1.8	
34NRS46H18	135	34.1	46.2	5/8	16	1 1/8	28.6	9/16	14.2	3.13	79.5	16.9	429	4.0	1.8	
34NRS48H29	140	35.1	47.6	1 1/8	29	1 13/16	46.0	5/8	15.9	3.50	88.9	16.9	429	4.0	1.8	
34NRS52H25	90	38.4	52.1	15/16	24	1 9/16	39.7	9/16	14.2	3.25	82.5	17.2	437	4.1	1.8	
34NRS53H37	120	38.9	52.7	1 5/8	41	2 11/32	59.5	5/8	15.9	3.75	95.3	17.3	439	4.4	2.0	
34NRS63H29	85	46.7	63.3	1 1/8	29	1 13/16	46.0	5/8	15.9	3.50	88.9	17.7	450	4.2	1.9	
34NRS68H37	70	50.4	68.3	1 5/8	41	2 11/32	59.5	5/8	15.9	3.75	95.3	18.1	460	4.6	2.1	

**General:**  
Air Inlet: 1/4" NPT  
Tool performance rated at 90 psi (620kPa) air pressure.

**Standard Equipment:**  
Suspension bail, hex socket

**Socket Selection:**  
See pages 45-47

# Ratchet Wrenches

Clutch Type

## Cleco®

### H16, H30, 41 & 60 Series

**Torque Range:**  
up to 415 Nm  
up to 306 Ft. Lbs

- Clutch activated air shut-off  
(H16, H30 & 60 series)  
Air shut-off (41 series)
- Non-Reversible



Model Number	Free Speed		Maximum Torque		Maximum Socket Size		"A"		"B"		"C"		Weight		Length	
	RPM	Ft. Lbs.	Nm	in.	mm	in.	mm	in.	mm	in.	mm	lbs.	kg	in.	mm	
H16NDR09H15	130	10.0	13.5	1/2	13	15/16	23.8	9/16	14.2	3.13	79.5	4.3	2.0	18.9	480	
H30NDR08H15	120	12.0	16.2	1/2	13	15/16	23.8	9/16	14.2	3.13	79.5	4.9	2.2	20.6	523	
41NDR236H15	360	23.0	31.1	1/2	13	15/16	23.8	9/16	14.2	3.13	79.5	5.7	2.6	17.7	449	
41NDR172H15	265	32.0	43.3	1/2	13	15/16	23.8	9/16	14.2	3.13	79.5	5.7	2.6	17.7	449	
41NDR130H15	200	42.0	56.9	1/2	13	15/16	23.8	9/16	14.2	3.13	79.5	6.1	2.8	18.8	478	
H30NDR08H16	110	13.0	17.6	5/8	16	1	25.4	9/16	14.2	3.13	79.5	4.9	2.2	20.6	523	
41NDR236H16	335	25.0	33.8	5/8	16	1	25.4	9/16	14.2	3.13	79.5	5.7	2.6	17.7	449	
41NDR172H16	245	34.0	46.0	5/8	16	1	25.4	9/16	14.2	3.13	79.5	5.7	2.6	17.7	449	
41NDR130H16	185	45.0	60.9	5/8	16	1	25.4	9/16	14.2	3.13	79.5	6.1	2.8	18.8	478	
H30NDR08H18	105	18.0	24.3	5/8	16	1 1/8	28.6	9/16	14.2	3.13	79.5	4.9	2.2	20.7	526	
41NDR236H18	315	29.0	39.2	5/8	16	1 1/8	28.6	9/16	14.2	3.13	79.5	5.8	2.6	17.7	449	
41NDR130H18	170	52.0*	70.4	5/8	16	1 1/8	28.6	9/16	14.2	3.13	79.5	6.1	2.8	18.8	478	
H16NDR09H20	110	16.0	21.6	3/4	19	1 1/4	31.8	9/16	14.2	3.13	79.5	4.4	2.0	19.1	485	
H30NDR08H20	100	19.0	25.7	3/4	19	1 1/4	31.8	9/16	14.2	3.13	79.5	4.9	2.2	20.8	528	
41NDR172H20	215	42.0	56.9	3/4	19	1 1/4	31.8	9/16	14.2	3.13	79.5	5.8	2.6	17.7	449	
41NDR130H20	160	56.0*	75.8	3/4	19	1 1/4	31.8	9/16	14.2	3.13	79.5	6.1	2.8	18.8	478	
60NDR092HD24	95	122.0	165.3	3/4	19	1 1/2	38.1	7/8	22.4	6.19	157.2	16.9	7.7	27.4	697	
H30NDR08H25	70	22.0	29.8	15/16	24	1 9/16	39.7	9/16	14.2	3.25	82.5	5.0	2.3	21.0	533	
41NDR172H25	155	53.0*	71.8	15/16	24	1 9/16	39.7	9/16	14.2	3.25	82.5	5.8	2.6	17.8	452	
41NDR130H25	115	70.0*	94.8	15/16	24	1 9/16	39.7	9/16	14.2	3.25	82.5	6.1	2.8	18.9	481	
60NDR092HD40	60	212.0	287.2	1 1/2	38	2 1/2	63.5	7/8	22.4	6.69	169.9	17.2	7.8	28.4	722	
60NDR092HD48	50	252.0	341.4	1 15/16	49	3	76.2	1	25.4	6.94	176.3	17.7	8.0	28.9	735	
60NDR092HD56	40	306.0	415.0	2-3/8	60	3 1/2	88.9	1	25.4	7.25	184.2	18.0	8.2	29.5	749	

**General:**

Air Inlet: 1/4" NPT (H16, H30),  
3/8" NPT (41), 1/2" NPT (60)  
Tool performance rated at 90 psi (620kPa) air pressure.

**Standard Equipment:**

H16, H30: Suspension bail, hex socket  
41: Hex socket  
60: Hex socket, reaction bar collar  
(1/2" hex opening for reaction bar)

**Socket Selection:**

See pages 45-47  
\*WARNING: these terminations are not recommended for applications over 50 Ft. Lbs. (68 Nm) torque.

## Standard Length 24, 34, H16, H30, 41 Series *(No additional cost)*

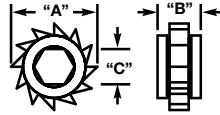

Termination		12	13	15	16	18	20	25	29	37
"A"		3/4	13/16	15/16	1	1 1/8	1 1/4	1 9/16	1 13/16	2 11/32
"B"		1/2	1/2	9/16	9/16	9/16	9/16	9/16	5/8	5/8
"C"		Socket Part Numbers								
Hex*										
1/4"	S.H.	28000	28020PT	28048	28075PT					
1/4"	D.H.	28001	28021PT	28051PT						
9/32"	S.H.	28012PT								
5/16"	S.H.	28002PT	28022	28040PT	28056		28101	28135		
5/16"	D.H.	28003	28023	28052PT	28078		28124PT			30434
11/32"	S.H.	28004PT	28024PT		28074PT	28097PT	28102			
11/32"	D.H.	28005								
3/8"	S.H.	28006	28026PT	28041	28057PT	28094PT	28160PT			
3/8"	D.H.	28007PT	28027	28042PT	28058PT		28123	28166PT		
7/16"	S.H.	28009PT†	28029PT	28043PT	28060PT	28081PT	28105PT	28136PT	28192PT	30418PT
7/16"	D.H.	28010†	28030	28044PT	28061PT	28082PT	28106PT	28137		30435PT
1/2"	S.H.		28031PT†	28046PT	28063	28083PT	28108	28139	28170	30423
1/2"	D.H.		28032†	28047	28064	28084PT	28109	28140PT		
9/16"	S.H.				28066	28087	28111	28141	28171	30432
9/16"	D.H.				28067PT	28088	28112	28142PT	28189PT	
5/8"	S.H.				28069PT†	28090PT	28115	28144PT	28172	
5/8"	D.H.				28070†	28091	28116PT	28145	28190PT	30431PT
11/16"	S.H.						28118PT	28146PT	28173	30433
11/16"	D.H.						28119	28147		
3/4"	S.H.						28121	28148PT	28174	30429PT
3/4"	D.H.						28122PT	28149PT	28191PT	
13/16"	S.H.							28150	28175	
13/16"	D.H.							28151PT		
7/8"	S.H.							28154	28176PT	30427PT
7/8"	D.H.							28155PT	28177	
15/16"	S.H.							28156PT	28179	30430
15/16"	D.H.							28157PT	28180PT	30434
1"	S.H.								28181	30428PT
1"	D.H.								28182PT	
1-1/16"	S.H.								28183PT	30436
1-1/16"	D.H.								28184	
1-1/8"	S.H.								28185PT	30417PT
1-1/8"	D.H.								28187	
1-3/16"	S.H.									30425PT
1-1/4"	S.H.									30419PT
1-5/16"	S.H.									30426
1-7/16"	S.H.									30420
1-1/2"	S.H.									30421
1-1/2"	D.H.									30437
1-5/8"	S.H.									30422PT
6 mm	S.H.	28016PT	28033PT	28055PT						
7 mm	S.H.	28017PT	28034PT	530440			28126	28163		
8 mm	S.H.	28002PT	28022	28040PT	28056					
8 mm	D.H.	28003	28023		28078					
9 mm	S.H.				28071					
9 mm	D.H.		28037							
10 mm	S.H.	28008PT	28028	28054PT	28059PT	28093	28104PT	28164		
11 mm	S.H.	28009PT†	28029PT	28043PT	28060PT	28081PT		28136PT	530460	
12 mm	S.H.			28045	28062		28107	28138PT		
13 mm	S.H.		28036	28053	28077PT	28096PT	28125PT	28161PT	530461	
14 mm	S.H.			530441	28065PT	28086PT	28110PT	28159		
15 mm	S.H.				28068PT	28089	28113	28143	530462	532431
15 mm	D.H.				28080PT	28095PT				
16 mm	S.H.				28100PT	28099		28167		
17 mm	S.H.				543126	28092PT	28117	28158	28193PT	
18 mm	S.H.						28120	28165PT		30439PT
19 mm	S.H.						28121	28148PT	28174	30429PT
19 mm	D.H.						28122PT	28149PT	28191PT	
21 mm	S.H.							28152		
22 mm	S.H.							28162		
23 mm	S.H.								28178PT	
24 mm	S.H.							28168		
29 mm	S.H.								28188PT	

\* S.H. = Single Hex; D.H. = Double Hex

† FRAGILE: For light duty operations only.

# Ratchet Wrenches

## Hex Socket Selection Charts

### Standard Length

#### 60 Series (No additional cost)

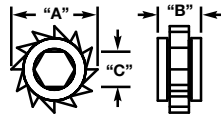

Termination	24	32	40	48	56
"A"	1 1/2	2	2 1/2	3	3 1/2
"B"	7/8	7/8	7/8	1	1
"C"	Hex*	Socket Part Numbers			
1/2"	S.H.	29015	29053		29121
1/2"	D.H.	29016			
9/16"	S.H.	29017			
9/16"	D.H.	29018			
5/8"	S.H.	29019	29035		
5/8"	D.H.	29020	29036		
11/16"	S.H.	29021	29037	507459	
11/16"	D.H.		29038		
3/4"	S.H.	29023	29039	507157	29115
3/4"	D.H.	29024	29040		523737
13/16"	S.H.		29041	29055	
13/16"	D.H.		29042		
7/8"	S.H.		29043	29057	29150
7/8"	D.H.		29044	29058	
15/16"	S.H.		29045	29059	29111
15/16"	D.H.		29046	29060	29112
1"	S.H.		29047	29061	29116
1"	D.H.		29048	29062	
1 1/16"	S.H.		29049	29063	29114
1 1/16"	D.H.		29050	29064	
1 1/8"	S.H.		29051†	29065	29090
1 1/8"	D.H.		29052†	29066	29091
1 3/16"	S.H.			29075	29118
1 1/4"	S.H.			29067	29092
1 1/4"	D.H.			29068	29093
1 5/16"	S.H.			29069	29094
1 5/16"	D.H.			29070	29095
1 3/8"	S.H.				29117
1 7/16"	S.H.			29071	29096
1 7/16"	D.H.			29072	
1 1/2"	S.H.			29073	29098
1 1/2"	D.H.			29074	
1 9/16"	S.H.				29152
1 5/8"	S.H.				29100
1 5/8"	D.H.				29101
1 11/16"	S.H.				29129
1 11/16"	D.H.				29103
1 3/4"	S.H.				29108
1 13/16"	S.H.				29104
1 13/16"	D.H.				29132
1 7/8"	S.H.				29106
1 15/16"	S.H.				29110†
2"	S.H.				29135
2 1/16"	S.H.				29137
2 1/16"	D.H.				29138
2 3/16"	S.H.				29139
2 1/4"	S.H.				29141
2 3/8"	S.H.				29143†
15 mm	S.H.	29028	507135		507161
18 mm	S.H.	29027			
21 mm	S.H.	29029	507136		
22 mm	S.H.		507134		
24 mm	S.H.		507132	507160	29119
26 mm	S.H.		507133	507157	
29 mm	S.H.		507134		
30 mm	S.H.		507137	507162	
36 mm	S.H.			29079	523738

### Power Socket Adapters

Adapts grooved sockets to square drive. Use with conventional square drive socket. (additional cost)

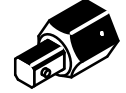

Part Number	Hex Size	Square Drive	Overall Length
A-312	3/8"	3/8"	0.94"
A-314	7/16"	3/8"	0.94"
A-514	7/16"	1/2"	1.09"
A-516	1/2"	1/2"	1.16"
A-518	9/16"	1/2"	1.16"
A-520	5/8"	1/2"	1.13"
A-524	3/4"	1/2"	1.13"

### Extended Length 24, 34, H16, H30, 41 Series

(Additional cost. Provides CCW tightening.)

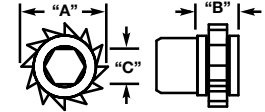

Termination	12	13	15	16	18	20	25	29
"A"	3/4	13/16	15/16	1	1 1/8	1 1/4	1 9/16	1 13/16
"B"	1/2	1/2	9/16	9/16	9/16	9/16	9/16	5/8
"C"	Hex*	Ext.	Socket Part Numbers					
5/16"	S.H.	1/2"		501060				
3/8"	S.H.	1/4"	20966					
3/8"	D.H.	1/4"		28652PT				
7/16"	S.H.	1/4"		28650PT				
7/16"	S.H.	1/2"		501056				
1/2"	S.H.	1/4"		28645PT				
1/2"	S.H.	1/2"		501059				
1/2"	S.H.	5/8"				501061		
1/2"	S.H.	3/4"		501054				
9/16"	S.H.	3/8"		501051				
9/16"	S.H.	1/2"		501053				
9/16"	S.H.	7/8"		28649PT				
5/8"	S.H.	3/8"		28648PT†				
1 3/16"	S.H.	3/4"					501062	
13 mm	S.H.	1/2"					501063	

### Double Extended 24, 34, H16, H30, 41 Series

(Additional cost)

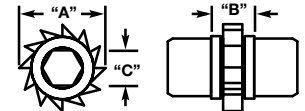

Termination	12	13	15	16	18	20	29
"A"	3/4	13/16	15/16	1	1 1/8	1 1/4	1 13/16
"B"	1/2	1/2	9/16	9/16	9/16	9/16	5/8
"C"	Hex*	Ext.	Socket Part Numbers				
5/16"	S.H.	1/4"	10642				
5/16"	D.H.	1/2"		501222			
3/8"	S.H.	3/8"		501225			
7/16"	S.H.	1/4"	18950				
7/16"	S.H.	1/2"			28787PT		
1/2"	D.H.	1/8"		28654			
1/2"	S.H.	1/4"		28663	28789		
1/2"	S.H.	7/16"		501221			
1/2"	D.H.	1/2"		28660PT			
9/16"	S.H.	1/8"		28659PT			
9/16"	D.H.	1/8"		28655PT			
9/16"	S.H.	1/4"		28656PT			
9/16"	D.H.	3/8"		28657PT			
9/16"	S.H.	1/2"				28791	501230
9/16"	D.H.	1/2"					501231
11/16"	S.H.	1/2"					28793
3/4"	D.H.	3/8"				28797†	
3/4"	S.H.	3/4"					28661
13 mm	S.H.	1/4"		501229	530024		
13 mm	S.H.	3/8"		501226			
13 mm	S.H.	1/2"		530741	530028		
13 mm	S.H.	3/4"		530742	531201		
15 mm	S.H.	1/4"		501227	530025	530002	501232
15 mm	S.H.	3/8"		501228		530001	501233
15 mm	S.H.	1/2"				530026	530003
15 mm	S.H.	3/4"				531200	530004

\* S.H. = Single Hex; D.H. = Double Hex

† FRAGILE: For light duty operations only.

## Extended Length H16, H30, 41 Series

(Additional cost. Provides CW tightening.)

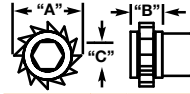

Termination	12	13	15	16	18	20	25	29	
"A"	3/4	13/16	15/16	1	1 1/8	1 1/4	1 9/16	1 13/16	
"B"	1/2	1/2	9/16	9/16	9/16	9/16	9/16	5/8	
"C"	Hex*	Ext.	Socket Part Numbers						
1/4" S.H.	1/4"	28300PT							
1/4" D.H.	3/8"	508406							
1.4" D.H.	1/2"	28314							
5/16" S.H.	1/4"	28301	28331	28353PT					
5/16" D.H.	1/4"	28316PT	28387PT						
5/16" S.H.	3/8"	28302PT	28333	28338					
5/16" D.H.	3/8"	28335		28352					
5/16" S.H.	1/2"	28320PT	28350PT		516546				
5/16" S.H.	3/4"	28392PT							
5/16" S.H.	7/8"	28313PT							
11/32" S.H.	1/4"	28303							
11/32" S.H.	1/2"	28336PT							
11/32" S.H.	3/4"	28304PT							
3/8" D.H.	1/8"	28347PT		28384PT					
3/8" S.H.	1/4"	28305PT	28323	28339PT		28354PT			
3/8" D.H.	1/4"	28317		28386PT					
3/8" S.H.	3/8"	28306	28324		28385PT				
3/8" S.H.	1/2"	28307		28355PT		28441PT			
3/8" D.H.	1/2"	28308							
3/8" S.H.	5/8"	28319							
3/8" D.H.	5/8"	28325PT							
3/8" S.H.	3/4"	28309PT		28356PT		28408PT			
3/8" D.H.	3/4"	28389							
3/8" S.H.	7/8"	28326							
3/8" S.H.	1"	28340							
3/8" D.H.	1"	28351							
7/16" S.H.	1/8"	508399							
7/16" S.H.	1/4"	28310PT†	28327	28341	28357		28439PT		
7/16" D.H.	1/4"	28334PT		28342		28358			
7/16" S.H.	3/8"	28311†	28328PT		28359				
7/16" S.H.	1/2"	28312PT	28329	28343PT		28360	28405	28410PT	
7/16" S.H.	5/8"	28344PT							
7/16" D.H.	5/8"	508397							
7/16" S.H.	3/4"	28361PT			28411				
7/16" S.H.	7/8"	28362PT							
7/16" D.H.	1"	508398							
1/2" S.H.	1/8"	508400		28363PT					
1/2" D.H.	1/8"	508404							
1/2" S.H.	1/4"	28345PT		28364PT	28406PT	28412PT			
1/2" D.H.	1/4"	28348PT							
1/2" S.H.	3/8"	28330		28366PT		28413PT	28465PT	28469PT	
1/2" S.H.	1/2"	28367PT			28402PT	28414PT		28478	
1/2" D.H.	1/2"	28349PT							
1/2" S.H.	5/8"	28368		28369PT		28401PT	28466PT		
1/2" D.H.	5/8"	28346			28437				
1/2" S.H.	3/4"	28370PT		28404PT	28415PT				
1/2" S.H.	7/8"	28416PT							
1/2" S.H.	1"	28371PT							
9/16" S.H.	1/8"	28372PT							
9/16" S.H.	1/4"	28373		28395PT	28418PT		28471PT		
9/16" D.H.	1/4"	28374							
9/16" S.H.	3/8"	28375PT†			28396PT				
9/16" D.H.	3/8"	28376†		28440					
9/16" S.H.	1/2"	28377†		28403	28419	28463PT			
9/16" D.H.	1/2"	28378PT†		28420		517065			
9/16" S.H.	5/8"	28379PT†		28397PT					
9/16" S.H.	3/4"	28393PT†		28421		28468PT			
9/16" D.H.	3/4"	28444PT			28464PT				
9/16" S.H.	7/8"	28380PT†							
9/16" D.H.	7/8"	516547							
9/16" S.H.	1"	517061							
5/8" S.H.	1/8"	28422							
5/8" S.H.	1/4"	28381PT†			28452PT		28479PT		
5/8" D.H.	1/4"	28423							
5/8" S.H.	3/8"	28382PT†							
5/8" S.H.	1/2"	28388PT†		28399PT	28424PT	28453PT			
5/8" S.H.	5/8"	28454PT							
5/8" S.H.	3/4"	28400PT		28426PT	28455				

Termination	12	13	15	16	18	20	25	29	
"A"	3/4	13/16	15/16	1	1 1/8	1 1/4	1 9/16	1 13/16	
"B"	1/2	1/2	9/16	9/16	9/16	9/16	9/16	5/8	
"C"	Hex*	Ext.	Socket Part Numbers						
5/8" D.H.	1"	28428PT							
11/16" S.H.	1/4"	28438PT							
11/16" D.H.	1/4"	28430PT							
11/16" S.H.	3/8"	28431PT					28456PT		
11/16" S.H.	1/2"	28432PT							
11/16" S.H.	1"	517062							
3/4" S.H.	1/4"	28433PT†							
3/4" S.H.	3/8"	28458PT							
3/4" S.H.	1/2"	28434PT							
3/4" S.H.	3/4"	28435PT		28459	28476				
3/4" S.H.	1"	28436					28470PT		
7/8" S.H.	1/4"	517063							
7/8" D.H.	5/8"	28461PT							
7/8" S.H.	1"	28462PT							
15/16" S.H.	1/2"	28474							
1" S.H.	1/2"	28472PT							
1-1/8" S.H.	1/2"	28477							
6 MM S.H.	1/4"	530453							
6 MM S.H.	1/2"	28321							
7 MM S.H.	1/4"	530454			516554				
7 MM S.H.	1/2"	28322		516553					
8 MM S.H.	1/4"	530455							
8 MM S.H.	1/2"	530450							
10 MM S.H.	1/4"	530456							
10 MM S.H.	3/8"	533472		28390PT					
10 MM S.H.	1/2"	530451		508405		516556			
11 MM S.H.	1/4"	530457							
11 MM S.H.	1/2"	530452							
11 MM S.H.	1/8"	28391PT							
13 MM S.H.	1/4"	28394PT							
13 MM S.H.	3/8"	525137							
13 MM S.H.	1/2"	533471		516552					
13 MM S.H.	1"	530519							
14 MM S.H.	1/4"	530516					28449PT		
14 MM S.H.	1/2"	28417PT							
15 MM S.H.	1/4"	530517					28450PT	517067	
15 MM D.H.	1/4"	530518							
15 MM S.H.	3/8"	28451PT							
15 MM D.H.	3/8"	28630							
15 MM S.H.	1/2"	516551							
15 MM D.H.	1/2"	516550							
15 MM S.H.	3/4"	28446PT							
17 MM S.H.	1/4"	28448PT							
17 MM S.H.	3/8"	517068							
17 MM S.H.	1/2"	28429PT		517060	514829				
17 MM D.H.	1"	28445PT							
18 MM S.H.	3/4"	543176		517069					

## Grooved 24, 34, H16, H30, 41 Series

Use with Power Socket Adapters (Additional cost)

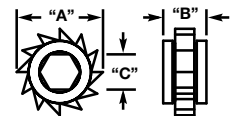

Termination	12	13	15	16	20	25	29
"A"	3/4	13/16	15/16	1	1 1/4	1 9/16	1 13/16
"B"	1/2	1/2	9/16	9/16	9/16	9/16	5/8
"C"	Hex*	Ext.	Socket Part Numbers				
1/4"	28741						
5/16"	28740						
3/8"	28739PT						
7/16"	28742PT	504772	28745PT	28750	28751PT	25737	
1/2"	28746		28748PT	28752PT		28766PT	
9/16"	28753PT			28768PT			
5/8"	28754PT						
3/4"	28755		28767PT				

\* S.H. = Single Hex; D.H. = Double Hex

† FRAGILE: For light duty operations only.



# Cleco®

**Durable.  
Economical.  
Low Maintenance.**

## Unbeatable Performance

We are constantly improving our products to guarantee you ideal productivity. The new Cleco H-Series pulse tools combine legendary durability with unmatched repeatability so that you will be able to complete every joint quickly and reliably.

### ■ Broad Tool Selection

With a variety of shut-off and non-shut-off pulse tools to choose from you are sure to find just the right Cleco pulse tool for the job.



### High Precision Shut-Off

mechanism ranges close to the characteristics of an electric tool at a tolerance of +/- 10% at Six Sigma.

### Efficient 3-Chamber Air Motor

- Speed governor
- Reduces your tightening time with increased torque and a usable high-end dynamic.
- Unique design reduces blade wear.
- Less vibration for increased user comfort
- Reduced air consumption



**3-Chamber Motor Housing**

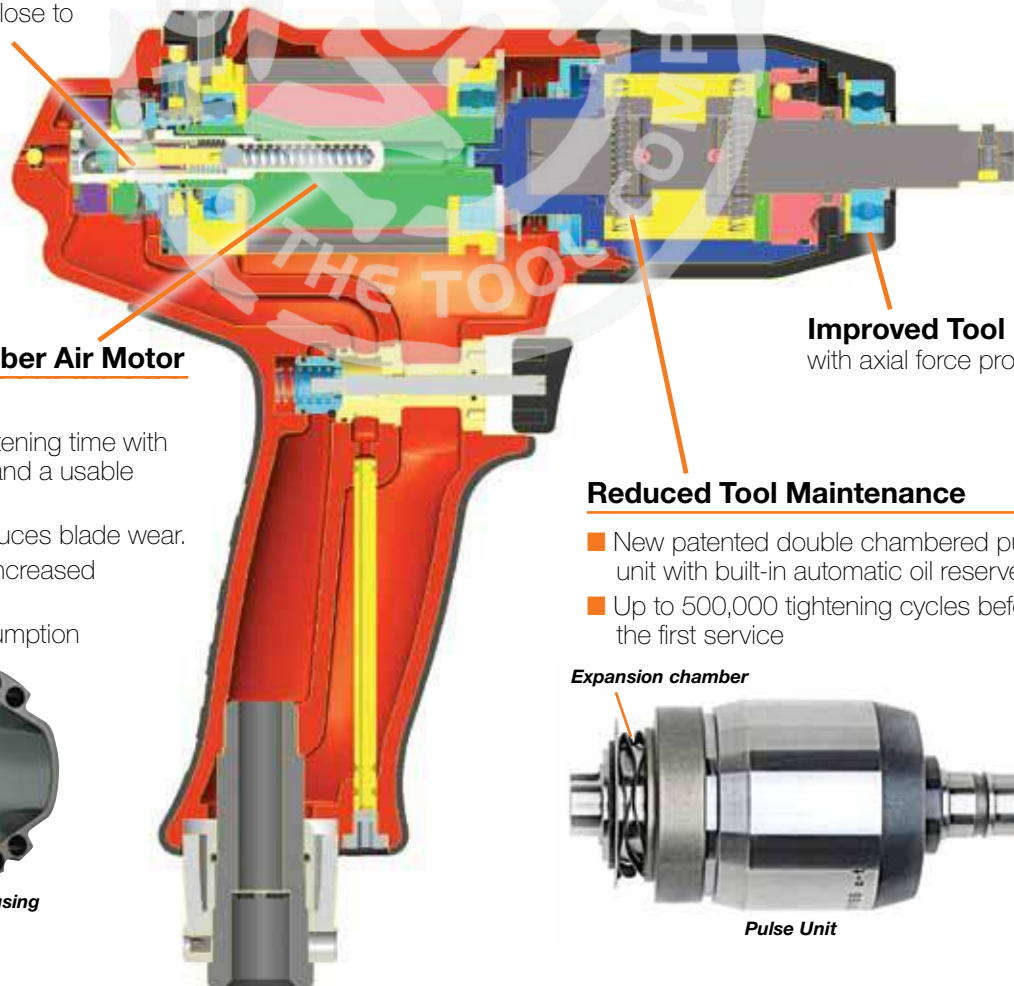

**Improved Tool End**  
with axial force protection

### Reduced Tool Maintenance

- New patented double chambered pulse unit with built-in automatic oil reserve
- Up to 500,000 tightening cycles before the first service

**Expansion chamber**



**Pulse Unit**

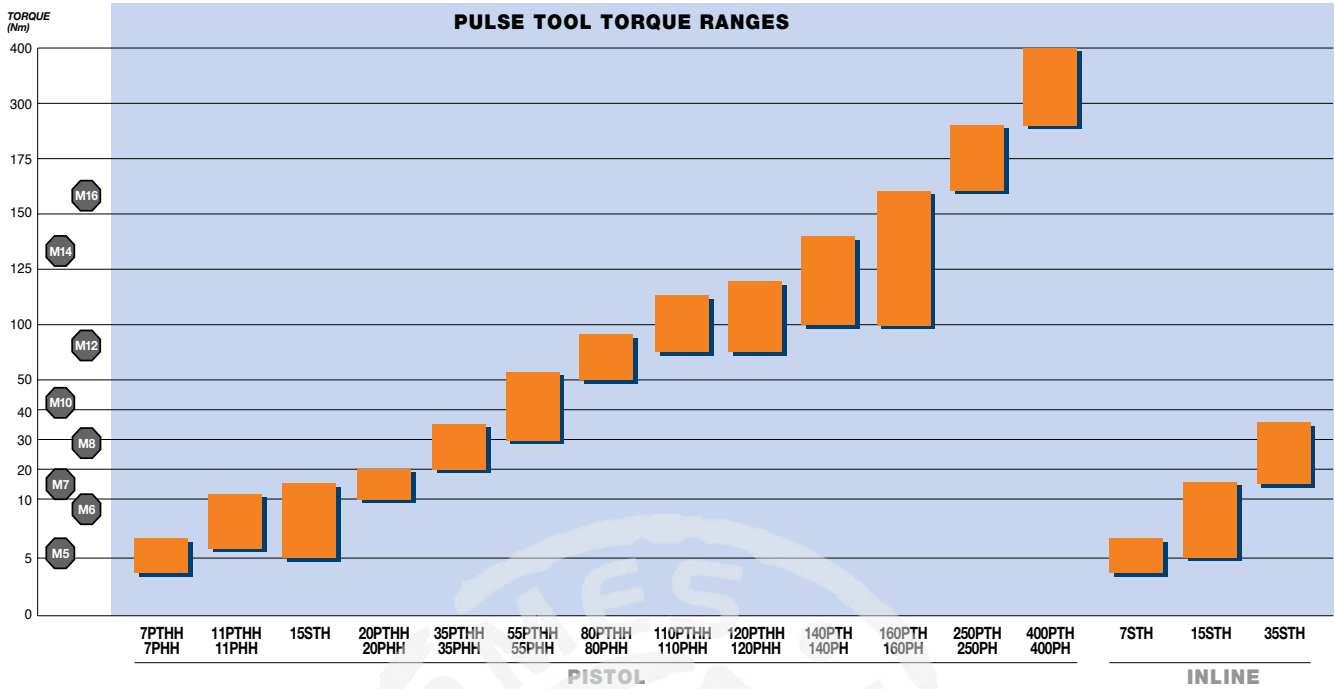

### Low Noise Levels

Noise levels of these tools are well below standard air tools for an operator-friendly environment. There is no loud metallic hammering under load.

### Ships Ready For Error Proofing

- Works with existing TVP torque verifier
- Located near air inlet to maximize ergonomics



Standard air signal indicating tool shutoff for use with Cleco TVP Error Proofing System.

### Easy Set-Up

- Insert 2mm hex into rear port of tool
- Positive stops in both directions to prevent loss and/or damage



### Adjustable Motor Speed

- Easily adjustable motor speed to insure accuracy on hard joints
- Can be locked in place to prevent accidental adjustment



# Pulse Nutrunners

Hydraulic Pulse Shut-Off & Non Shut-Off



## H-Series PTH

**Torque Range:** 4 - 120 Nm  
3.0 - 88.8 Ft. Lbs  
**Bolt Size:** M5 - M12  
#10 - 1/2"

- Inertia shut-off
- Motor governor equipped
- External torque adjustment
- External speed control
- Torque signal port
- Adjustable pulse unit volume simplifies maintenance
- Market-leading repeatability
- Reversible
- Oilless blades



## C-Series PTHC & PTHFC

**Torque Range:** 100 - 400 Nm  
74 - 295 Ft. Lbs  
**Bolt Size:** M12 - M20  
1/2" - 3/4"

- Hydraulic pulse shut-off
- Motor governor equipped
- External torque adjustment
- External speed control
- Reversible
- Oilless blades
- Torque signal port



## C-Series STHFC & STHF

**Torque Range:** 2.6 - 35 Nm  
1.9 - 26 Ft. Lbs  
**Bolt Size:** M5 - M8  
#10 - 3/8"

- Hydraulic pulse shut-off
- Motor governor equipped
- External torque adjustment
- External speed control
- Reversible
- Oilless blades
- Torque signal port



### Model Number Nomenclature

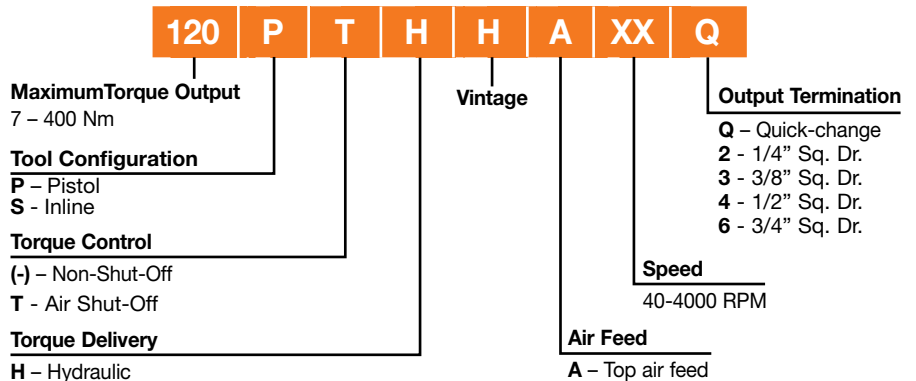

	Model Number	Drive Type	Torque Range		Free Speed	Weight		Air Consumption			
			Ft.Lbs.	Nm	RPM	lbs.	kg	NPT	Hose I.D.	SCFM	
S H U T O F	<b>H-Series – Pistol Grip – Shut-Off Models</b>										
	7PTHH352	1/4" Sq.Dr.	3.0-5.1	4-7	3500	1.74	0.79	1/4"	3/8"	7.06	
	7PTHH35Q	1/4" QC	3.0-5.1	4-7	3500	1.74	0.79	1/4"	3/8"	7.06	
	11PTHH352	1/4" Sq.Dr.	4.4-8.1	6-11	3500	1.81	0.82	1/4"	3/8"	7.06	
	11PTHH35Q	1/4" QC	4.4-8.1	6-11	3500	1.87	0.85	1/4"	3/8"	7.06	
	11PTHH353*	3/8" Sq.Dr.	4.4-8.1	6-11	3500	1.83	0.83	1/4"	3/8"	7.06	
	20PTHH40Q	1/4" QC	7.4-14.7	10-20	4000	1.92	0.87	1/4"	1/2"	8.7	
	20PTHH403*	3/8" Sq.Dr.	7.4-14.7	10-20	4000	1.90	0.86	1/4"	1/2"	8.7	
	35PTHH40Q	1/4" QC	14.8-25.8	20-35	4000	2.31	1.05	1/4"	1/2"	15.9	
	35PTHH403*	3/8" Sq.Dr.	14.8-25.8	20-35	4000	2.31	1.05	1/4"	3/8"	15.9	
	55PTHH403*	3/8" Sq.Dr.	22.1-40.5	30-55	4000	2.54	1.15	1/4"	3/8"	15.9	
	80PTHH35Q	7/16" QC	36.9-59.0	50-80	3500	3.20	1.45	1/4"	3/8"	19.4	
80PTHH354	1/2" Sq.Dr.	36.9-59.0	50-80	3500	3.10	1.40	1/4"	3/8"	19.4		
110PTHH30Q	7/16" QC	55.3-81.1	75-110	3000	3.75	1.70	3/8"	1/2"	19.4		
120PTHH304	1/2" Sq.Dr.	55.3-88.8	75-120	3000	3.75	1.70	3/8"	1/2"	19.4		
O F	<b>C-Series – Pistol Grip – Shut-Off Models</b>										
	140PTHFC25Q	7/16" QC	74-103	100-140	2500	5.7	2.6	3/8"	1/2"	25.4	
160PTHFC256	3/4" Sq.Dr.	74-118	100-160	2500	5.7	2.6	3/8"	1/2"	25.4		
F	<b>C-Series – Pistol Grip – Shut-Off Models – Trigger Throttle</b>										
	250PTHFC226	3/4" Sq.Dr.	118-184	160-250	2200	8.8	4.0	3/8"	1/2"	33.5	
400PTHFC206	3/4" Sq.Dr.	185-295	250-400	2000	11.7	5.3	3/8"	1/2"	33.5		
S H U T O F	<b>In-Line – Push-to-Start</b>										
	7STHFA55Q	1/4" QC	1.9-4.9	2.6-6.6	5500	1.8	0.83	1/8"		7.0	
	35STHFA40Q	7/16" QC	12-26	15-35	4000	3.1	1.4	1/4"	3/8"	15.9	
	35STHFA404	1/2" Sq.Dr.	12-26	15-35	4000	2.9	1.3	1/4"	3/8"	15.9	
S H U T O F	<b>C-Series – In-Line – Lever</b>										
	7STHFC55Q	1/4" QC	1.9-4.9	2.6-6.6	5500	2.1	0.93	1/8"		7.0	
	15STHFC40Q	1/4" QC	3.6-11	5.0-15	4000	2.4	1.1	1/4"	3/8"	16.5	
	35STHFC40Q	7/16" QC	12-26	15-35	4000	3.3	1.5	1/4"	3/8"	15.9	
	35STHFC404	1/2" Sq.Dr.	12-26	15-35	4000	3.3	1.5	1/4"	3/8"	15.9	
15STHC40Q	1/4" QC	3.6-11	5.0-15	3000	2.4	1.1	1/4"	3/8"	16.5		

PTHHA=Top Air Inlet

(\*) 7/16" Quick Change Chuck available separately as an accessory

**General:**

Tool performance rated @ 87 psi (6 bar) air pressure.

**Standard Equipment:**

Suspension bail and torque adjusting wrench.  
Torque signal port (pistol grip models only)

**Optional Equipment:**

Additional accessories: Page 53



# Pulse Nutrunners

Hydraulic Pulse Non Shut-Off

# Cleco®

## H-Series PH Non-Shut-Off

**Torque Range:** 4 - 120 Nm  
2.9 - 88.5 Ft. Lbs

**Bolt Size:** M5 - M12  
#10 - 1/2"

- External speed control
- Reversible
- Oilless blades 



	Model Number	Drive Type	Torque Range		Free Speed	Weight		Air Consumption		
			Ft.Lbs.	Nm	RPM	lbs.	kg	NPT	Hose I.D.	SCFM
NON SHUT OFF	<b>H-Series – Pistol Grip – Non Shut-Off Models</b>									
	7PHH602	1/4" Sq.Dr.	2.9-5.2	4-7	6000	1.70	0.77	1/4"	3/8"	8.7
	7PHH60Q	1/4" QC	2.9-5.2	4-7	6000	1.74	0.79	1/4"	3/8"	8.7
	11PHH653*	3/8" Sq.Dr.	4.4-8.1	6-11	6500	1.74	0.79	1/4"	3/8"	10.5
	11PHH652	1/4" Sq.Dr.	4.4-8.1	6-11	6500	1.72	0.78	1/4"	3/8"	10.5
	11PHH65Q	1/4" QC	4.4-8.1	6-11	6500	1.76	0.80	1/4"	3/8"	10.5
	20PHH753*	3/8" Sq.Dr.	7.4-14.7	10-20	7500	1.85	0.84	1/4"	3/8"	17.3
	20PHH75Q	1/4" QC	7.4-14.7	10-20	7500	1.90	0.86	1/4"	3/8"	17.3
	35PHH653*	3/8" Sq.Dr.	14.7-25.8	20-35	6500	2.25	1.02	1/4"	3/8"	19.4
	35PHH65Q	1/4" QC	14.7-25.8	20-35	6500	2.29	1.03	1/4"	3/8"	15.9
	55PHH603*	3/8" Sq.Dr.	22.1-40.5	30-55	6000	2.47	1.12	1/4"	3/8"	22.9
	80PHH604	1/2" Sq.Dr.	36.9-59.0	50-80	6000	3.09	1.40	1/4"	3/8"	26.5
80PHH60Q	7/16" QC	36.9-59.0	50-80	6000	3.13	1.41	1/4"	3/8"	26.5	
110PHH55Q	7/16" QC	55.3-81.1	75-110	5500	3.68	1.66	3/8"	1/2"	30.0	
120PHH554	1/2" Sq.Dr.	55.3-88.5	75-120	5500	3.64	1.65	3/8"	1/2"	30.0	
OFF	<b>High Torque Pistol Grip – Non-Shut-Off Models</b>									
	140PH45Q	7/16" QC	74-103	100-140	4500	5.7	2.6	3/8"	1/2"	31.7
	160PH456	3/4" Sq.Dr.	74-118	100-160	4500	5.7	2.6	3/8"	1/2"	31.7
	250PHF406	3/4" Sq.Dr.	118-184	160-250	4000	8.6	3.9	3/8"	1/2"	40.6
	400PHF356	3/4" Sq.Dr.	184-295	250-400	3500	11.5	5.2	3/8"	1/2"	42.3

PTHHA=Top Air Inlet

(\* 7/16" Quick Change Chuck available separately as an accessory.

For 7-75 Series Models, small handle can be ordered by substituting "S" for "L" in model number.

**General:**

Tool performance rated @ 87 psi (6 bar) air pressure.

**Standard Equipment:**

Suspension bail and torque adjusting wrench.

**Optional Equipment:**

Additional accessories: Page 53

## Rubber Tool Stand



Part Number	Tool Series
931041 (one piece)	D & H Series 7PTH – 120PTH
930119 (two pieces)	C Series 140/160PTH/PH/ 250PTH / 400PTH

## TVP-100 Torque Signal Kit

Air signal to indicate shut-off.

Part Number	Tool Series
934918	PTH series pulse tools and vintage shut-off tools only

## 7/16" Quick Change Chuck Adapter

Part Number	Tool Series
935472	To convert 11/20/35/55PTHH/PTHHA/ PHH/PHHA to a Quick-Change chuck



## Vibration Absorber

Part No.	Fits Model
935965	35/55PTHHA/PHHA
935966	80/110/120PTHHA/PHHA



## Hydraulic Filler Unit

Part Number			Tool Series
Filler Unit Complete	Filler Unit Only	Connector Only	
928477		932072	140/160 PTHC../ PH..
928473	928483	928485	250/400 PTHC../ PH..
928475			35 STH..
928474		931663	7 STH..
		928486	15 STH..

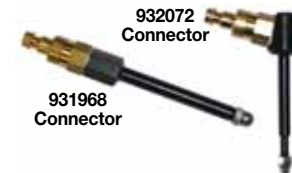

## Reserve Oil Filling Set

Part No.
936695PT



## Hydraulic Oil

Part Number	Container Size
539317	One Quart



## Covers

Part No.	Fits Model
937442PT	Protective cover for 7/11/20PTHHA/7/11/20PHHA
937443PT	Protective cover for 35PTHHA/35PHHA
937444PT	Protective cover for 55PTHHA/55PHHA
937445PT	Protective cover for 80PTHHA/80PHHA
937446PT	Protective cover for 110/120PTHHA/110/120PHHA
937447PT	Protective cover for 7/11/20PTHH/7/11/20PHH
937448PT	Protective cover for 35PTHH/35PHH
937449PT	Protective cover for 55PTHH/55PHH
937450PT	Protective cover for 80PTHH/80PHH
937451PT	Protective cover for 110/120PTHH/110/120PHH



## Cleco®

### Telescopic Impact Wrenches

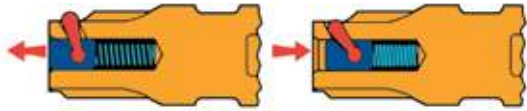

#### Positive Lock Socket Retainer

With the positive lock socket retainer, sockets snap on... and stay on until released. Offered on spline drives, the retainer can be serviced without disassembling the tool.

#### Exclusive through-bolt construction reduces replacement costs

Steel front end/motor housing/handle are clamped together by four high-strength steel bolts. This exclusive feature provides better tool performance, eliminates stripped threads and loose inserts in motor housing.



#### Positive oil-foam lubrication system reduces major cause of impact wrench maintenance.

Cleco impact wrenches feature a unique oil-foam bath that provides positive lubrication for the hammer, anvil and other working parts.



The system is designed so that if the impact mechanism runs low on 30 wt. oil, the tool will stop running, thus eliminating one of the major causes of impact wrench failure ... lack of lubrication. By simply refilling the oil reservoir, the tool can be returned to service. Other impact wrenches soon throw off grease; run dry causing extra wear that shortens tool life and increases maintenance cost.

### Proven heavy-duty telescoping impact mechanism adds power...cuts weight...reduces shock to the operator.

The smooth-hitting Cleco telescopic impact mechanism has only three major parts - hammer, anvil and rotor... providing more power directly to the fastener. The hammer is splined to the inside of the motor, which then impacts directly on the anvil, delivering more power per blow.

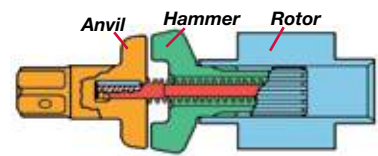

#### Other important features include:

- Comfortable grip handle
- Outside, inside triggers and pistol grip models
- Multiposition dead handle, and spade type "D" handle available
- Throttle can be feathered for speed control
- Simple face-type reversing valve simplifies maintenance
- Forged hammer and anvil for greater durability
- Rotor bearings and steel motor end plates fit either end of motor, reducing spare parts inventory and repair time.

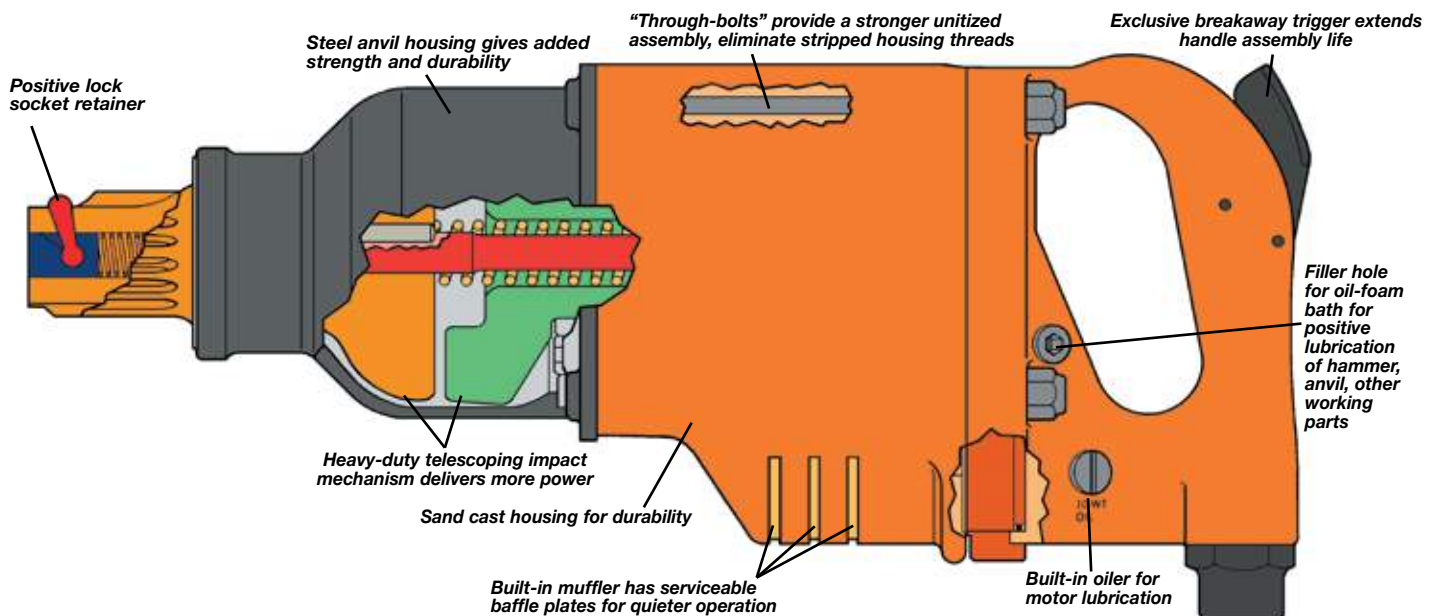

The Impact Wrench Bolt Selection Chart will assist you in selecting impact wrenches for specific applications. Torque and tension figures are based on 70% of the proof load of a given size and grade UNC bolt. Torque values are based on non-lubricated (dry) conditions. Bolt grades and sizes are those which are the most commonly secured with impact wrenches.

## SAE Grade 1

Bolt Diameter	1/4"	5/16"	3/8"	7/16"	1/2"	9/16"	5/8"	3/4"	7/8"	1"	1-1/8"	1-1/4"	1-3/8"	1-1/2"	1-5/8"	1-3/4"	
Torque	Ft.-lb.	3	6	11	18	28	43	55	97	155	230	340	480	660	860	-	-
	Nm	4.1	8.1	15	24	38	58	75	132	210	312	460	650	900	1,170	-	-
Tension	lb.	730	1,210	1,800	2,460	3,280	4,200	5,200	7,000	10,000	14,000	18,200	23,000	28,000	34,600	-	-
	kN	3.24	5.38	8.0	10.9	14.6	18.7	23.1	31.1	47.1	62.3	81	102	126	154	-	-

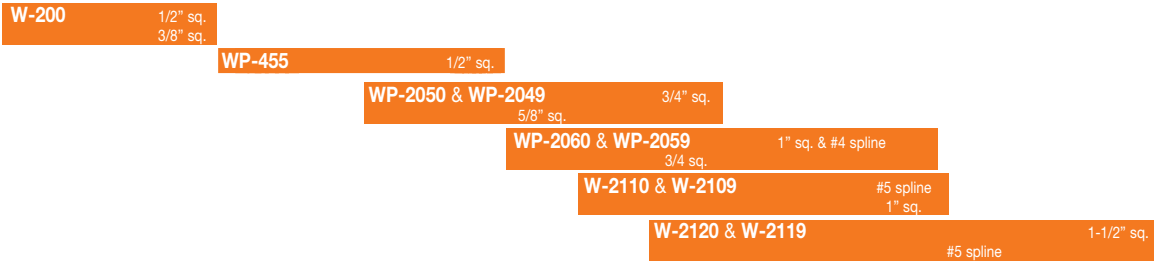

## SAE Grade 5

Bolt Diameter	1/4"	5/16"	3/8"	7/16"	1/2"	9/16"	5/8"	3/4"	7/8"	1"	1-1/8"	1-1/4"	1-3/8"	1-1/2"	1-5/8"	1-3/4"	
Torque	Ft.-lb.	8	16	28	46	70	110	140	250	405	600	770	1,080	1,470	1,950	-	-
	Nm	10.8	21.7	38	62	95	149	190	340	550	810	1,040	1,460	1,930	2,640	-	-
Tension	lb.	1,900	3,100	4,600	6,350	8,450	10,900	13,500	20,000	27,400	36,000	41,000	52,000	64,000	77,000	-	-
	kN	8.4	13.8	20.4	28.2	37.6	48.5	60	89	122	160	182	231	285	342	-	-

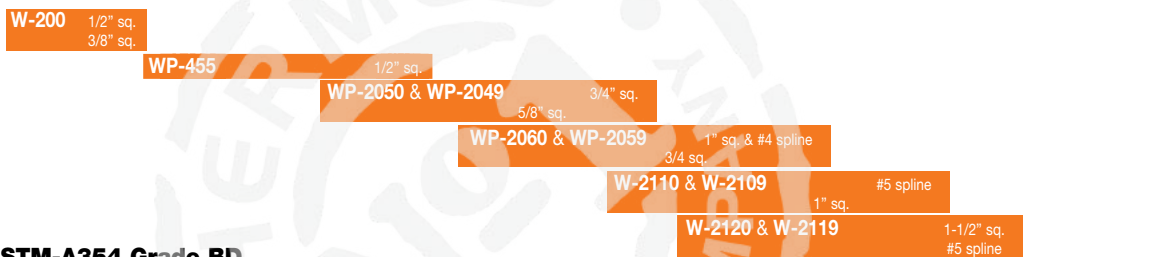

## SAE Grade 8 / ASTM-A354 Grade BD

Bolt Diameter	1/4"	5/16"	3/8"	7/16"	1/2"	9/16"	5/8"	3/4"	7/8"	1"	1-1/8"	1-1/4"	1-3/8"	1-1/2"	1-5/8"	1-3/4"	
Torque	Ft.-lb.	11	23	40	65	99	159	198	350	566	848	1,245	1,750	2,375	3,135	-	-
	Nm	14.9	31.2	54.2	88	134	216	268	475	767	1,150	1,690	2,370	3,220	4,250	-	-
Tension	lb.	2,740	4,400	6,510	8,930	11,920	15,290	18,980	28,050	38,800	50,900	66,360	84,000	103,570	125,330	-	-
	kN	12.2	19.6	28.9	39.7	53	68	84.4	125	172	226	295	374	461	557	-	-

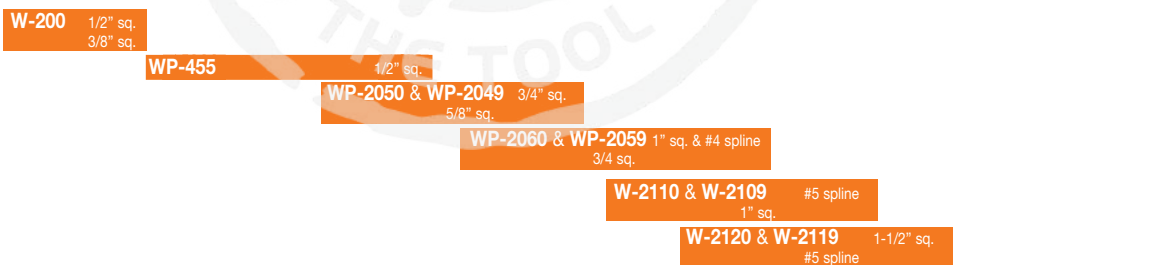

## ASTM A325\*

Bolt Diameter	1/4"	5/16"	3/8"	7/16"	1/2"	9/16"	5/8"	3/4"	7/8"	1"	1-1/8"	1-1/4"	1-3/8"	1-1/2"	1-5/8"	1-3/4"
Torque	Ft.-lb.	1					200	355	570	850	1,060	1,495	1,960	2,600	-	-
	Nm						271	481	773	1,150	1,440	2,030	2,660	3,530	-	-
Tension	lb.						10,000	28,000	39,000	51,000	56,000	71,000	85,000	103,000	-	-
	kN						44.5	124	173	227	249	316	378	458	-	-



## ASTM A490\*

Bolt Diameter	1/4"	5/16"	3/8"	7/16"	1/2"	9/16"	5/8"	3/4"	7/8"	1"	1-1/8"	1-1/4"	1-3/8"	1-1/2"	1-5/8"	1-3/4"
Torque	Ft.-lb.	1					250	435	715	1,070	1,580	2,125	2,780	3,700	-	-
	Nm						339	590	970	1,451	2,125	2,882	3,770	5,020	-	-
Tension	lb.						24,000	35,000	49,000	64,000	80,000	102,000	121,000	148,000	-	-
	kN						107	156	218	285	356	454	538	658	-	-



\*Note: ASTM-325 and ASTM A490 bolts are used on structural steel applications. Torque and tension values are based on running the nut beyond the proof load of the bolt by the turn-of-the-nut method. For detailed information, consult the bolt manufacturer.



# Impact Wrenches

Inline, Pistol Grip & Spade Handle

## Cleco®

### WL & WP Series

<b>Torque Range:</b>	<b>Bolt Size:</b>
20 - 2450 Nm	M10 - M30
15 - 1800 Ft. Lbs	7/16" - 1 1/2"

- Lever and trigger start
- Reverse or forward bias
- 6" extended and spline drives available



WL-200-3



WP-255-3P



WP-455-4P



WP-2049-6

### WT Series Spade Handle

<b>Torque Range:</b>	<b>Bolt Size:</b>
1000 - 4000 Nm	M30 - M36
750 - 3000 Ft. Lbs	1 3/8" - 1 1/2"

- Inside or outside lever
- Positive lock socket retainer (spline drive)
- Multiposition dead handle
- Oil foam bath
- Reverse or forward bias



WT-2109-8



WTS-2119

Model Number	Bolt Size		Square Drive	Recommended Torque Range		Impacts per Minute	Free Speed	Length		Weight		Side to Center		Air Consumption		
	Gr. 5	Gr. 9.8		ft.-lbs.	Nm			in.	mm	lbs.	kg	in.	mm	NPT	Hose I.D.	SCFM
	in.	mm	in.	in.	mm	in.	mm									

**Inline – Lever Start**

WL-200-3	7/16	M10	3/8	15-50	20-68	3,200	3,000	8.5	216	3.1	1.4	1	25	1/4"	1/4"	18
WL-200-4	1/2	M10	1/2	15-60	20-81	3,200	3,000	8.5	216	3.4	1.5	1	25	1/4"	1/4"	18

**Pistol Grip – Trigger Start**

WP-255-3P	7/16	M10	3/8	60-75	80-100	1,150	9,500	5.7	145	2.6	1.2	1	25	1/4"	1/4"	30
WP-455-4R	1/2	M20	1/2	37-370	50-502	1,400	6,500	7	176	5.3	2.4	-	-	1/4"	1/4"	40
WP-455-4P***	1/2	M20	1/2	37-370	50-502	1,400	6,500	7	176	5.3	2.4	-	-	1/4"	1/4"	40
WP-2050-6	7/8	M20	3/4	125-600	170-800	1,000	6,000	6.4	162	7.8	3.5	1.6	42	3/8"	3/8"	45
WP-2060B-6	1 1/8	M24	3/4	250-700	350-950	1,000	4,000	7.8	197	12	5.4	1.8	46	3/8"	3/8"	60
WP-2060B-8	1 1/8	M24	1	250-900	350-1200	1,000	4,000	7.8	197	12.1	5.5	1.8	46	3/8"	3/8"	60
WP-2110B-8	1 3/8	M30	1	750-1650	1000-2250	880	4,600	9.5	241	20.8	9.4	2.2	56	1/2"	3/8"	100

**Pistol Grip – Trigger Start – Biased Reverse Power\*\*\*\***

WP-2049-6	7/8	M20	3/4	125-550	170-750	1,000	6,200	6.4	162	7.8	3.5	1.6	42	3/8"	3/8"	45
WP-2059-6	1 1/8	M24	3/4	250-700	350-950	1,000	4,000	7.8	197	12	5.4	1.8	46	3/8"	3/8"	60
WP-2059-8	1 1/8	M24	1	250-800	350-1100	1,000	4,000	7.8	197	12.1	5.5	1.8	46	3/8"	3/8"	60
WP-2059-8-6E**	1 1/8	M24	1	250-750	350-1000	1,000	4,000	13.8	350	14.3	6.5	1.8	46	3/8"	3/8"	60
WP-2109B-8	1 3/8	M30	1	750-1650	1000-2250	880	4,300	9.5	241	20.8	9.4	2.2	56	1/2"	3/8"	100
WPS-2109B	1 3/8	M30	#5 Spl.	750-1800	1100-2450	880	4,300	9.8	248	21.3	9.6	2.2	56	1/2"	3/8"	100

\* Quick change chuck  
 \*\* 6" Extended spindle  
 \*\*\* Pin retainer  
 \*\*\*\*Breakaway torque capacity in reverse:  
 2049 Series: 750 ft.-lbs. (1000 Nm)  
 2059 Series: 1200 ft.-lbs. (1600 Nm)  
 2109 Series: 2500 ft.-lbs. (3400 Nm)

**General:**  
 Tool performance rated at 90 psi (620kPa) air pressure.

**Optional Equipment:**  
 86909 Suspension bail for WL-200.  
 Additional accessories: Pages 63

**Standard Equipment:**  
 Operating instructions & service manual

Model Number	Inside Trigger	Outside Trigger	Suitable for Bolt Size		Square Drive	Recommended Torque Range		Impacts Per Minute	Free Speed	Length		Weight		Side to Center		Air Consumption		
			in.	mm		in.	ft.-lbs.			Nm	RPM	in.	mm	lbs.	kg	in.	mm	NPT

**Trigger Start - Spade Handle**

WT-2110-8			1 1/2	M30	1	750-1650	1000-2250	880	4,600	12.9	327	21	9.5	2.2	56	1/2"	1/2"	100
WTS-2120			1 1/2	M36	#5 Spl.	1200-2800	1600-3800	850	3,300	14.3	362	27.6	12.5	2.3	59	1/2"	5/8"	105
WT-2120-12	W-2120-12		1 1/2	M36	1 1/2	1200-3000	1600-4000	850	3,300	14.3	362	27.6	12.5	2.3	59	1/2"	5/8"	105

**Trigger Start - Spade Handle - Biased Reverse Power\*\***

WT-2109-8	W-2109-8		1 3/8	M30	1	750-1650	1000-2250	880	4,300	12.9	327	21	9.5	2.2	56	1/2"	1/2"	100
WTS-2109			1 3/8	M30	#5 Spl.	800-1800	1100-2450	880	4,300	13.1	333	21.5	9.8	2.2	56	1/2"	1/2"	100
WT-2119-12			1 1/2	M36	1 1/2	1200-2600	1600-3500	820	3,300	14.3	362	29	13.1	2.3	59	1/2"	5/8"	105
WTS-2119	WS-2119		1 1/2	M36	#5 Spl.	1200-2500	1600-3400	820	3,300	14.3	362	29	13.1	2.3	59	1/2"	5/8"	105

\*6" Extended spindle  
 \*\*Breakaway torque capacity in reverse:  
 2109 Series: 2500 ft.-lbs. (3400 Nm)  
 2119 Series: 3500 ft.-lbs. (4700 Nm)

**Standard Equipment:**  
 Operating instructions & service manual  
 Dead handle bracket  
 Dead Handle

**Optional Equipment:**  
 Additional accessories: Pages 63

**General:**  
 Tool performance rated at 90 psi (620kPa) air pressure.

# Cleco®

## **Screwdriver balance arms absorb torque, support weight and improve productivity.**

Cleco balance arms are engineered to deliver longer service life using durable components, rugged design and operator-sensitive features.

These arms absorb the torque produced by the screwdriver, eliminating torque reaction to the operator. Balanced by springs or air cylinders, the arm and not the operator supports the weight of the tool. By reducing the fatigue factors, the operator productivity is improved.

Tool movement and placement over the fastener is virtually effortless since most moving parts of the balance arm are mounted on ball bearings. Access to the tool is easily changeable by adjusting the springs or cylinder supporting the forearm.

Arm components and materials are selected for strength and rigidity. Precision aluminum sand castings used in the articulating arm section are light but sturdy.

Over 25 models of the Cleco screwdriver balance arms are available. Air cylinder models are capable of supporting tools weighing up to 10 lbs. (4.5 kg.). Spring models will support tools weighing up to 5 lbs. (2.3 kg.). Both styles have torque capacities of 10 ft. lbs. (13.5 Nm). Arms can be post mounted, wall mounted or mounted on an adjustable height post. Tool holders for all models will accommodate most major brands of air tools...straight and pistol.

### **Tool Holders**

Selecting the proper tool holder for the tool used on Cleco balance arms enhances the ergonomic benefits of the arm. Tool holders allow the tool to swing, swivel and rotate, enabling the operator to work more comfortably and productively.

Standard and extended tool holders are available for parallel balance arms. Both models hold the tool perpendicular to the work, and are ideal for self-tapping and thread forming applications. Tool diameter capacity is up to 1 3/4 inch (45mm).

Manifold tool holders used on SBA and CSBA balance arms suspend the tool from the air inlet. They allow the tool to swing (or swivel when equipped with the optional swivel assembly) for ease of tool movement.





## Cleco®

### Ergonomic Tool Balancers

Capacity:  
0.5 - 20.5 kg  
1.0 - 45 Lbs.

External tension adjustment

- 360° Swivel
- Retracting in-line cable

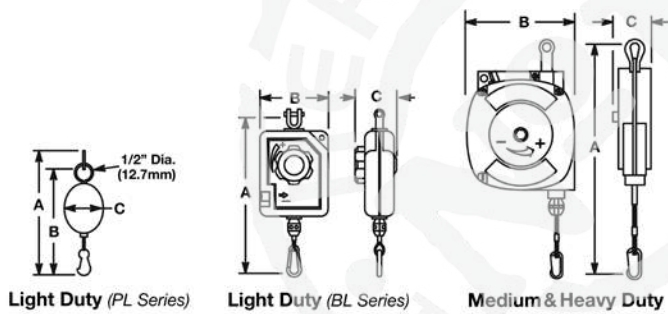

Model Number	Lock Feature	Capacity		"A"		"B"		"C"		Weight	
		lbs.	kg	in.	mm	in.	mm	in.	mm	lbs.	kg
<b>Light Duty – 4.6 ft. (1.4m) Cable Travel</b>											
PL-12A	–	12.0-1.0	5.5-0.5	6.8	171	5.1	130	2.3	58	–	–
<b>Light Duty – 5.0 ft. (1.5m) Cable Travel</b>											
200427	–	2.0-0	.9-0	10.9	277	4.4	112	1.6	41	1.3	0.6
200428	–	4.0-2.0	1.8-.9	10.9	277	4.4	112	1.6	41	1.3	0.6
200429	–	5.0-3.0	2.3-1.4	10.9	277	4.4	112	1.6	41	1.3	0.6
<b>Light Duty – 5.2 ft. (1.6m) Cable Travel</b>											
BL-2A	–	2.0-1.0	0.9-0.5	10.4	263	4.0	102	2.2	56	1.1	0.5
BL-4A	–	4.0-2.0	1.8-0.9	10.4	263	4.0	102	2.2	56	1.1	0.5
<b>Light Duty – 6.7 ft. (2.0m) Cable Travel</b>											
BL-6A	–	6.0-4.0	2.7-1.8	12.9	327	5.5	140	3.1	79	3.3	1.5
BLL-6A	Ratchet	6.0-4.0	2.7-1.8	12.9	327	5.5	140	3.1	79	3.3	1.5
BL-8A	–	8.0-6.0	3.6-2.7	12.9	327	5.5	140	3.1	79	3.3	1.5
BLL-8A	Ratchet	8.0-6.0	3.6-2.7	12.9	327	5.5	140	3.1	79	3.3	1.5
<b>Medium Duty – 6.6ft. (2.0m) Cable Travel</b>											
BM-13A	Automatic	13-9.0	5.9-4.1	13.8	350	6.9	175	4.5	114	9.0	4.1
BML-13A	Automatic/Ratchet	13-9.0	5.9-4.1	13.8	350	6.9	175	4.5	114	9.0	4.1
BM-18A	Automatic	18-13	8.2-5.9	13.8	350	6.9	175	4.5	114	9.0	4.1
<b>Medium Duty – 6.0ft. (1.8m) Cable Travel</b>											
BM-25A	Automatic	25-18	11.4-8.2	20.7	527	7.8	197	6.6	169	19	8.6
BM-35A	Automatic	35-25	15.9-11.4	20.7	527	7.8	197	6.6	169	19	8.6
BM-45A	Automatic	45-35	20.5-15.9	20.7	527	7.8	197	6.6	169	19	8.6

# General Accessories

Air Cylinder & Spring Balance Arms

## Cleco®

- Ball bearing construction
- Supports tools weighing up to 5 lbs. (spring models) or up to 10 lbs. (air cylinder models).
- Post, wall, or adjustable height post mounting
- Single or parallel arms

*Air Cylinder  
Single Arm Post  
CPBA-18*

*Air Cylinder  
Parallel Arm  
Adjustable Height  
CPBA-18-AH*

*Spring  
Parallel Arm Post  
PBA-18*

*Spring  
Single Arm  
Adjustable Height  
SBA-18-AH*

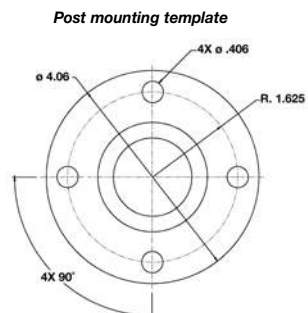

TOOLS NOT INCLUDED

Single Arms		Parallel Arms		Dimensions							
Model No.	Ordering No.	Model No.	Ordering No.	A		B		C		D	
				in.	mm	in.	mm	in.	mm	in.	mm
CSBA18	520160	CPBA-18	520170	12	305	18	457	18	457	-	-
CSBA-24	520200			12	305	24	610	18	457	-	-
CSBA-30	520201	CPBA-30	520203	12	305	30	762	18	457	-	-
CSBA-12-AH	520165	CPBA-12-AH	520178	12	305	12	305	-	-	30	762
CSBA-18-AH	520162	CPBA-18-AH	520172	12	305	18	457	-	-	30	762
CSBA-30-AH	520167	CPBA-30-AH	520175	12	305	30	762	-	-	30	762
		CPBA-30-WM	520207	12	305	30	762	-	-	-	-

**Air Cylinder Models**

AH = Adjustable Height  
 WM = Wall Mounted  
 Tool weight capacity: 10 lbs. (4.6 kg)  
 Torque capacity: 10 ft. lbs. (13.5 Nm)

**Standard Equipment**  
 Operating Instructions and Service Manual.  
 Regulator for Air Cylinders.  
 Threaded Nipples for CSBA Models  
 1/4 NPT Hex Nipple: 204032  
 1/4 NPT x 1/8 NPT Hex Reducer  
 Nipple: 204137

**Optional Equipment**  
 Additional accessories: See page 62.

Single Arms		Parallel Arms		Dimensions							
Model No.	Ordering No.	Model No.	Ordering No.	A		B		C		D	
				in.	mm	in.	mm	in.	mm	in.	mm
SBA-12	520001	PBA-12	520007	12	305	12	305	18	457	-	-
SBA-18	520004	PBA-18	520010	12	305	18	457	18	457	-	-
		PBA-24	520045	12	305	24	610	18	457	-	-
SBA-12-AH	520003	PBA-12-AH	520009	12	305	12	305	-	-	30	762
SBA-18-AH	520006	PBA-18-AH	520012	12	305	18	457	-	-	30	762
SBA-24-AH	520110	PBA-24-AH	520047	12	305	24	610	-	-	30	762
SBA-30-AH	520044	PBA-30-AH	520050	12	305	30	762	-	-	30	762
		PBA-18-18-AH	520036	18	457	18	305	-	-	30	762
		PBA-12-WM	520008	12	305	12	305	-	-	-	-
SBA-30-WM	520043			12	305	30	762	-	-	-	-

AH = Adjustable Height  
 WM = Wall Mounted  
 Tool weight capacity: 5 lbs. (2.3 kg)  
 Torque capacity: 10 ft. lbs. (13.5 Nm)

**Standard Equipment**  
 Operating Instructions and Service Manual.  
 Threaded Nipples for SBA Models  
 1/4 NPT Hex Nipple: 204032  
 1/4 NPT x 1/8 NPT Hex Reducer  
 Nipple: 204137

**Optional Equipment**  
 Additional accessories: See page 62.

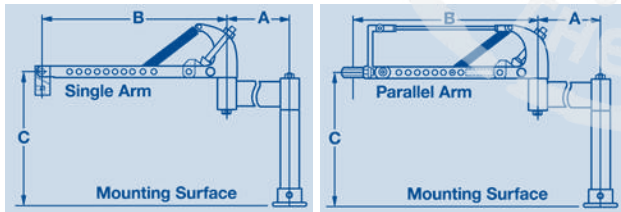

**Balance Arm Operating Envelope**

MODEL	R1 MAX		R1 MIN		R2 MAX		R2 MIN		H MAX		H MIN	
	in.	mm	in.	mm	in.	mm	in.	mm	in.	mm	in.	mm
SBA-12	24	610	2	51	18	457	8	203	15	381	6	152
SBA-18	30	762	6	152	20	508	7	178	15	381	0	0
PBA-12	26	660	3	76	20	508	7	178	17	432	8	203
PBA-18	32	813	8	203	22	559	6	152	17	432	2	51

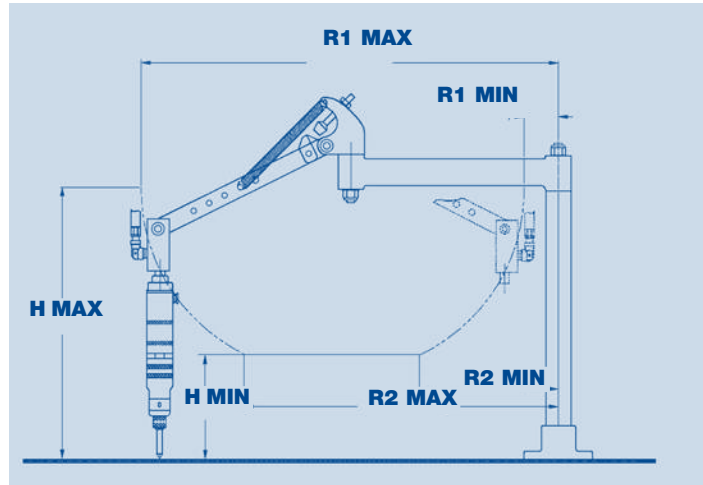

**XX BA - XX - XX - XX**

**Series**  
 CS - Air cylinder, single arm  
 S - Spring, single arm  
 CP - Air cylinder, parallel arm  
 P - Spring, parallel arm

**Arm Extension**  
 12" 24"  
 18" 30"  
 (12" unless specified)

**Mount**  
 - - Post  
 AH - Adjustable Height  
 WM - Wall Mount

**Adjustable Arm Extension**  
 12" 24"  
 18" 30"

**Tool Type**  
 BA - Balance Arm

# General Accessories

Air Cylinder & Spring Balance Arm Accessories

## Single Arm Tool Holders

Part Number	Description
201690*	Manifold tool holder
201601*	Swivel manifold tool holder

\*Use of 201601 requires 201690.

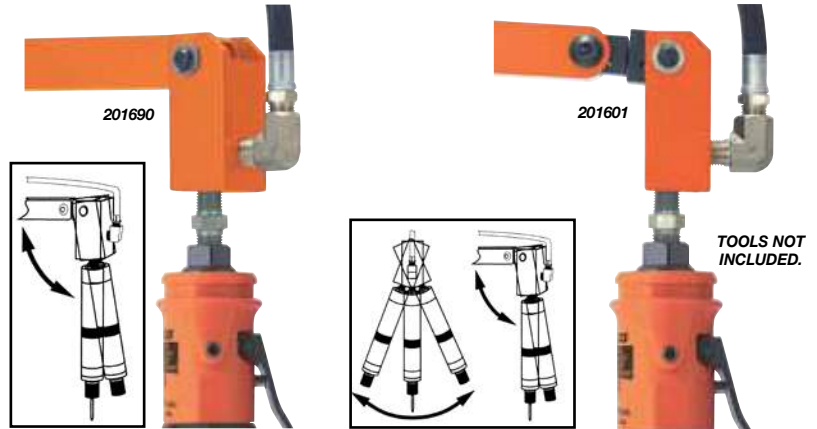

## Parallel Arm Tool Holders

Part Number	Description
201675	Parallel tool holder
204167	Extended parallel tool holder
201607	Swivel tool holder (small)
201608	Swivel tool holder (large)



## Articulating Arm Extensions

Part Number	Length (inches)
204014	12
204122	18
204119	24
204120	30

## Conversion Kits for Cleco Screwdriver Balance Arms

To Convert Balance Arms		Part No.
From	To	
SBA-12	PBA-12*	521041
SBA-18	PBA-18*	521042
Spring	Cylinder	201606
SBA or PBA Standard Duty	SBA or PBA Heavy Duty**	521060

\* Conversion kits for -24 and -30 models are available upon request.  
 \*\* Has four springs to support heavier tools or longer arms.

## Air Hoses

Part Number	Hose I.D.		Fittings (NPT)		Length	
	in.	mm	in.	mm	ft.	m
A139856	3/16	4.7	1/8	1/8	6.0	1.8
45-1307	3/16	4.7	1/8	1/4	7.0	2.1
45-1408	1/4	6.4	1/4	1/4	8.0	2.4
45-1409	1/4	6.4	1/8	1/4	8.0	2.4
45-1508	5/16	7.9	1/4	1/4	8.0	2.4
45-1610	3/8	9.5	3/8	3/8	10	3.0
45-1810	1/2	12.7	3/8	1/2	10	3.0
45-1812	1/2	12.7	1/2	1/2	12	3.7
45-1825	1/2	12.7	1/2	1/2	25	7.6

**General:** 3/16" & 1/4" hoses have braided covers, all others have neoprene covers.

**\*Note:** 3/8"-24 is a straight thread



## Activeswivel

Part No.	NPT in.	Air Flow		Max. Pressure		Weight	
		SCFM	m <sup>3</sup> /min	psig	bar	lbs.	kg
SW-102	1/4	25	7.1	150	10.4	0.20	0.09
SW-103	3/8	45	12.7	150	10.4	0.40	0.18
SW-104	1/2	65	18.4	150	10.4	0.80	0.36
SWR-102*	1/4	25	7.1	150	10.4	0.25	0.11

\* NOTE: Equipped with built-in flow regulator.

## Quick Disconnect Fittings

Fitting Type*	NPT in.	Nominal Size		
		1/4"	3/8"	1/2"
<b>Coupler (male NPT)</b>				
	1/8	45-0710	-	-
	1/4	45-0711	45-0713	-
	3/8	45-0712	-	-
	1/2	-	-	45-0717
<b>Coupler (female NPT)</b>				
	1/4	-	-	-
	3/8	45-0732	45-0734	45-0736
<b>Nipple (male NPT)</b>				
	1/8	45-0720	-	-
	1/4	-	45-0724	-
	3/8	45-0722	45-0725	45-0726
	1/2	-	-	45-0727
<b>Nipple (female NPT)</b>				
	1/4	-	45-0744	-
	3/8	45-0742	45-0745	45-0746
	1/2	-	-	45-0747
<b>Nipple (with hose barbs)</b>				
	1/4**	45-0748	-	-
	1/2**	-	-	45-0753

\* NOTE: Nipples of one size will not fit couplers of another size.

\*\* NOTE: Indicates inside diameter of hose.

NOTE: 1/4" nominal will pass 49 cfm free air @ 90 psi, but pressure drop exceeds 10 psi with air flow over 30 cfm.

3/8" nominal will pass 90 cfm free air @ 90 psi, but pressure drop exceeds 10 psi with air flow over 53 cfm.

1/2" nominal will pass 168 cfm free air @ 90 psi, but pressure drop exceeds 10 psi with air flow over 109 cfm.

## Lubricants

Part Number	Size	Description	M.S.D.S. No.
<b>Oils</b>			
540397	1 qt. plastic	Air line oil	CPT-153
533485	1 gal. metal	Air line oil	CPT-153
536333	1 gal. metal	High film strength	CPT-154
45-0918	1 qt. plastic	Air line oil ( <i>Dotco</i> )	CPT-155
45-0919	1 gal metal	Air line oil ( <i>Dotco</i> )	CPT-155
539317	1 qt. plastic	Hydraulic oil ( <i>Pulse</i> )	CPT-157
<b>Greases</b>			
513156	18 oz. can	Teflon grease	CPT-145
540394	2.8 oz. tube	Teflon grease	CPT-145
45-0983	2 oz. tube	Dotco gear grease	CPT-147
45-0980	2 oz. tube	Dotco gear lube	CPT-148

NOTE: Under normal conditions of use, lubrication products sold separately for or used within these tools should not cause an exposure hazard. Refer to the Material Safety Data Sheet (M.S.D.S.) for Safety and Disposal information. M.S.D.S. sheets shown in the chart are available upon request from Cooper Tools.



**Push Type Grease Gun**

Part Number: 45-1982





## Quality Fastener Tools

For more than half a century Apex has maintained the position of world leader in industrial fastening tools. Many power and insert bits, socket combinations and other drivers/adapters pioneered by Apex have today become industry standards, while Apex quality, service and selection give you unsurpassed value.

### More Quality For Your Money

Apex quality starts with the selection of raw materials. Only carefully chosen, high grade tool steel is used to make Apex industrial fastener tools. Next, each tool is precision machined from solid bar stock to exacting standards of accuracy. You always get a snug, secure fit – a fit that is not possible from stamped tools.

Finally, each Apex fastener tool is tempered with our exclusive heat treating process. During this step the degree of hardness is determined based upon the application.

### Fast Delivery

All Apex standard catalog items are available off-the-shelf for immediate delivery. If you need special assistance with your order, your Apex manufacturer's representative can handle any questions you may have.

### Special Orders

Apex offers the broadest selection of screw driver and nut runner tools available, from bits, sockets and universal wrenches to extensions, adapters and nut setters. If you have a special application, contact your Apex representative. We may have what you need in stock, or can design and produce special fastener tools for almost any application.

### Ordering Information

Apex products are distributed world-wide. For a catalog of the complete line of Apex quality fastener tools or to locate your nearest Apex distributor, visit our website at [www.apex-tools.com](http://www.apex-tools.com).

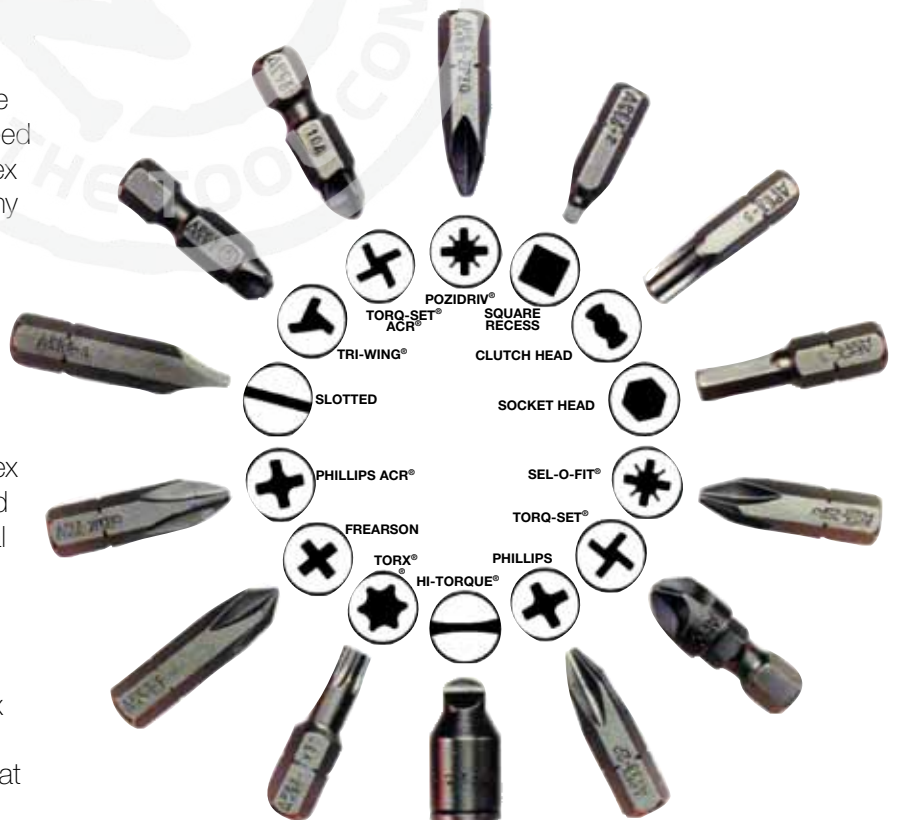

## Insert Bits

(1/4" hex for socket head cap screws and set screws)

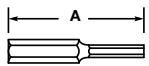

Part Number	Hex Size (in.)	"A"		Cap Screw	Set Screw
		in.	mm		
185-00	1/16	1.00	25.4	1	5.6
185-0	5/64	1.00	25.4	2.3	8
185-1	3/32	1.00	25.4	4.5	10
185-9	7/64	1.00	25.4	6	—
185-2	1/8	1.00	25.4	8	1/4
185-10	9/64	1.00	25.4	8	—
185-3	5/32	1.31	33.3	10	5/16
185-4	3/16	1.31	33.3	1/4	3/8
185-5	7/32	1.31	33.3	—	7/16
185-6	1/4	1.31	33.3	5/16	1/2
185-7	5/16	1.25	31.8	3/8	5/8
185-8	3/8	1.25	31.8	7/16, 1/2	3/4

## Square Drive Adapter

(1/4" hex drive sockets) Use with Quick Change and Bit & Finder Models, except as noted.

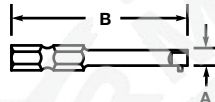

Part Number	"A" Sq. Drive	"B"		Bushing Number
		in.	mm	
EX250-2	1/4	2.00	50.8	—
EX250-3	1/4	3.00	76.2	847295*
EX250-4	1/4	4.00	101.6	—
EX250-6	1/4	6.00	152.4	—
EX370	3/8	1.63	41.3	—
EX370-3	3/8	3.00	76.2	847295*
EX500-2	1/2	2.00	50.8	—
EX500-3	1/2	3.00	76.2	—

\*Note: Required for bit and finder models.

## Hex Extensions

Part Number	Hex Drive (in.)	Type of Lock	Overall Length	
			in.	mm

### Male Hex Drive with 1/2" Male Square

EX-501-3	7/16	Pin	3	76
EX-501-4	7/16	Pin	4	102
EX-501-6	7/16	Pin	6	152

### Male Hex Drive with 3/8" Male Square

EX-371-3	7/16	Pin	3	76
EX-371-4	7/16	Pin	4	102
EX-371-6	7/16	Pin	6	152



## Hex Drive Nutsetters

Part Number	Size (in.)	Overall Length (in.)	Socket Nose Diameter (in.)
-------------	------------	----------------------	----------------------------

### 7/16" 6 Point

6N-1416-3	1/2	3	13/16
6N-1416-4	1/2	4	13/16
6N-1418-3	9/16	3	7/8
6N-1418-4	9/16	4	7/8
6N-1420-3	5/8	3	1
6N-1420-6	5/8	6	1



## Insert Bits

Used with Bit Holders  
(all bits are 1.0" (25.4 mm) long)



Point Size	Part Number		Wood		Machine & Self-Tapping			
	Phillips	Pozi-Drive	Flat & Oval	Round	Flat, Oval & Pan	Fillister	Truss	Binding
0	446-0	446-1P2D	0.1	0.1	0.1	0.1	0.1	0.1
1	HPL-1	440-1PZD	2-4	2-4	2-4	2-4	2-4	2-4
2	HPI-2	440-2PZD	5-8	5-10	5-10	5-10	6-10	5-10
3	HPI-3	440-3PZD	10-16	12-16	12-16	12-5/16	12-16	12-1/4

## 6 Point Sockets

Part No.	Hex Opening	Overall Length	Nose End Diameter	Drive End Diameter	Opening Depth
----------	-------------	----------------	-------------------	--------------------	---------------

### 3/8" Square Drive Sockets, SAE

3112	3/8	1 1/4	19/32	3/4	1/4
3114	7/16	1 1/2	11/16	3/4	9/32
3116	7/16	1/2	1 1/2	13/16	11/32
3118	7/16	9/16	1-1/2	7/8	7/16

### 1/2" Square Drive Sockets, SAE

5112	3/8	1 1/2	5/8	15/16	1/4
5114	7/16	1 1/2	11/16	15/16	9/32
5116	1/2	1 1/2	13/16	15/16	11/32
5120	5/8	1 1/2	1	1	7/16
5122	11/16	1 1/2	1 1/8	1 1/8	7/16
5124	3/4	1 1/2	1 1/8	1 1/8	15/32

### 3/4" Square Drive Sockets, SAE

7128	7/8	2	1 1/2	1 1/2	9/16
7132	1	2	1 5/8	1 5/8	5/8
7136	1 1/8	2 1/8	1 3/4	1 3/4	3/4
7140	1 1/4	2 1/8	2	1 3/4	13/16
7144	1 3/8	2 1/8	2 1/8	2 1/8	13/16
7148	1 1/2	2 1/4	2 1/4	2 1/8	1

### 1" Square Drive Sockets, SAE

8132	1	2 1/8	1 5/8	2	13/16
8140	1 1/4	2 1/8	2 1/8	2 1/8	13/16
8144	1 3/8	2 1/8	2 1/8	2 1/8	13/16
8148	1 1/2	2 1/4	2 1/4	2 1/8	15/16
8156	1 3/4	2 3/8	2 5/8	2 5/8	11/16
8164	2	2 5/8	3	2 5/8	1 3/16

### 1 1/2" Square Drive Sockets, SAE

9156	1 3/4	2 7/8	2 7/8	3	1 1/8
9160	1 7/8	3	3 1/8	3	1 1/4
9164	2	3 1/8	3 1/4	3 1/4	1 3/8
9172	2 1/4	3 1/4	3 3/8	3 1/4	1 1/2

### 3/8" Square Drive Sockets, Metric

12mm13	12	38.1	19.1	19.1	7.2
14mm13	14	38.1	22.2	22.2	11.1
16mm13	16	38.1	23.8	23.8	11.1

### 1/2" Square Drive Sockets, Metric

16mm15	16	38.1	25.4	25.4	11.1
18mm15	18	38.1	28.6	28.6	11.1
20mm15	20	38.1	31.7	31.7	11.9
22mm15	22	38.1	33.3	33.3	14.3

### 5/8" Square Drive Sockets, Metric

24mm16	24	51	38.1	38.1	15.9
--------	----	----	------	------	------

### 3/4" Square Drive Sockets, Metric

28mm17	28	54	44.4	44.4	19.1
30mm17	30	54	47.6	44.4	19.1
32mm17	32	54	50.8	44.4	20.6
34mm17	34	54	54.0	54.0	20.6
36mm17	36	57	57.1	54.0	23.8

### 1" Square Drive Sockets, Metric

32mm18	32	54	54.0	54.0	20.6
34mm18	34	54	54.0	54.0	20.6
36mm18	36	57	57.1	54.0	23.9
38mm18	38	57	57.1	54.0	23.9
42mm18	42	60	63.5	54.0	23.9
46mm18	46	64	69.8	66.7	26.9



# APEX® $\mu$ -Guard™

## Quality Anti-Mar Fastener Tools Begin With Quality Fastener Tools.

Apex  $\mu$ -Guard™ provides a protective barrier between genuine Apex fastener tools and your finely finished workpiece. The free-spinning patent-pending design provides maximum protection for polished and highly sensitive surfaces.

Apex  $\mu$ -Guard™ covering is made of a thermo plastic urethane (TPU elastomer) which cushions against costly incidental side impacts. It offers the lowest coefficient of friction for maximum tool efficiency. It is also non-removable for tamper resistance.

With Apex  $\mu$ -Guard™ you get the proven Apex fastener tool fit and performance plus the best protection available against marring and in-system damage.

$\mu$ -Guard™ is your guard against the potential hazards caused by rotational friction.



*If it doesn't say Apex on the outside, how can you be sure of what's on the inside?*

### Prevents Side Impact Damage



### Free-Spinning Design



### Virtually Damage Free



## μ-Guard Sockets

(Includes socket and cover)



Part Number	Socket	Drive End			Socket Length	Fastener End			Assembly Features
		Size	Type	Sex		Size	Type	Sex	
UGS-AB710	10MM21	1/4	Square	F	standard	10 mm	Hex	F	FS
UGS-AB710-01	M-10MM21	1/4	Square	F	standard	10 mm	Hex	F	FS, M
UGS-AB710-02	MB-10MM21	1/4	Square	F	standard	10 mm	Hex	F	FS, M, B
UGS-BA610	10MM13	3/8	Square	F	standard	10 mm	Hex	F	FS
UGS-BA610-01	M-10MM13	3/8	Square	F	standard	10 mm	Hex	F	FS, M
UGS-BB710	10MM23	3/8	Square	F	long	10 mm	Hex	F	FS
UGS-BB710-01	M-10MM23	3/8	Square	F	long	10 mm	Hex	F	FS, M
UGS-BB710-02	MB-10MM23	3/8	Square	F	long	10 mm	Hex	F	FS, M, B
UGS-BB713	13MM23	3/8	Square	F	long	13 mm	Hex	F	FS
UGS-BB713-01	M-13MM23	3/8	Square	F	long	13 mm	Hex	F	FS, M
UGS-BB713-02	MB-13MM23	3/8	Square	F	long	13 mm	Hex	F	FS, M, B
UGS-CB713	13MM25	1/2	Square	F	long	13 mm	Hex	F	FS
UGS-CB713-03	SF-13MM25	1/2	Square	F	long	13 mm	Hex	F	FS, SF
UGS-CB715	15MM25	1/2	Square	F	long	15 mm	Hex	F	FS
UGS-CB715-03	SF-15MM25	1/2	Square	F	long	15 mm	Hex	F	FS, SF
UGS-CB718	18MM25	1/2	Square	F	long	18 mm	Hex	F	FS
UGS-CB718-03	SF-18MM25	1/2	Square	F	long	18 mm	Hex	F	FS, SF

If your tool is not shown in the table of representative products above, please contact your Apex representative.



## μ-Guard Extensions

(Includes extension and cover)



Part Number	Extension	Drive End			Extension Length	Socket End			Assembly Features*
		Size	Type	Sex		Size	Type	Sex	
UGE-A2A	EX-250-2	1/4	Hex	M	2	1/4	Square	M	FS
UGE-A4A	EX-250-4	1/4	Hex	M	4	1/4	Square	M	FS
UGE-A6A	EX-250-6	1/4	Hex	M	6	1/4	Square	M	FS
UGE-B2A	EX-370-2	1/4	Hex	M	2	3/8	Square	M	FS
UGE-B4A	EX-370-4	1/4	Hex	M	4	3/8	Square	M	FS
UGE-B6A	EX-370-6	1/4	Hex	M	6	3/8	Square	M	FS
UGE-B3C	EX-376-3	3/8	Square	F	3	3/8	Square	M	FS
UGE-B6C	EX-376-6	3/8	Square	F	6	3/8	Square	M	FS
UGE-B12C	EX-376-12	3/8	Square	F	12	3/8	Square	M	FS
UGE-C4C	EX-508-4	1/2	Square	F	4	1/2	Square	M	FS
UGE-C8C	EX-508-8	1/2	Square	F	8	1/2	Square	M	FS
UGE-C12C	EX-508-12	1/2	Square	F	12	1/2	Square	M	FS

If your tool is not shown in the table of representative products above, please contact your Apex representative.



## μ-Guard Bit Holders

(Includes bit holder and cover)



Part Number	Bit Holder	Drive End			Socket Length	Fastener End			Assembly Features
		Size	Type	Sex		Size	Type	Sex	
UGH-1NAA	M-490	1/4	Hex	M	2 31/32	1/4	Hex	F	FS, M, ET
UGH-1AAA	M-490-2	1/4	Hex	M	2	1/4	Hex	F	FS, M, ET
UGH-2NBG	838	3/8	Square	F	1 1/2	1/4	Hex	F	FS, ET
UGH-1NBG	M-838	3/8	Square	F	2 5/8	1/4	Hex	F	FS, M, ET
UGH-2NBC	835	3/8	Square	F	1 1/2	5/16	Hex	F	FS, ET
UGH-1NBC	M-835	3/8	Square	F	2 3/4	5/16	Hex	F	FS, M, ET
UGH-2NBD	855	1/2	Square	F	1 1/2	5/16	Hex	F	FS, ET
UGH-1NBD	M-855	1/2	Square	F	2 3/4	5/16	Hex	F	FS, M, ET
UGH-2NCK	QR-308	3/8	Square	F	1 3/4	1/4	Hex	F	FS, QR
UGH-2NCF	QR-508	1/2	Square	F	2 1/8	1/4	Hex	F	FS, QR
UGH-2NCJ	QR-314	3/8	Square	F	2	7/16	Hex	F	FS, QR
UGH-2NCL	QR-514	1/2	Square	F	2 1/8	7/16	Hex	F	FS, QR

If your tool is not shown in the table of representative products above, please contact your Apex representative.

### \*Features Abbreviations

**FS** Free Spinning Tool is able to rotate independently of Cover  
**M** Magnetic Tool includes magnet to hold the position of the fastener during fastening operation  
**B** Bolt Clearance Tool is spring-loaded to allow bolt or nut to retract into the socket body  
**SF** Surface Drive Tool has radiused corners to allow easier alignment and engagement of fastener  
**ET** Exposed Tip Cover extends beyond end of Bit Holder to shield the majority of a standard 1 inch long Insert Bit.

**QR** Quick Release Tip of Insert Bit will not be covered to allow easier fastener engagement. Tool has tension feature to allow quick & easy change between bits. Cover will not extend beyond end of Bit Holder

**Notes:** Reported lengths are based on uncovered tool length only for reference. Cover may extend beyond end of tool by 2 mm unless otherwise noted.



# Conversion Tables

Millimeter – Decimal – Fraction

mm	Dec.	in.	mm	Dec.	in.	mm	Dec.	in.	mm	Dec.	in.	mm	Dec.	in.
0.100	.0039		<b>5.159</b>	<b>.2031</b>	<b>13/64</b>	10.300	.4055		15.400	.6063		20.400	.8031	
0.200	.0079		5.200	.2047		<b>10.319</b>	<b>.4063</b>	<b>13/32</b>	<b>15.478</b>	<b>.6094</b>	<b>39/64</b>	20.500	.8071	
0.300	.0118		5.300	.2087		10.400	.4094		15.500	.6102		20.600	.8110	
<b>0.397</b>	<b>.0156</b>	<b>1/64</b>	5.400	.2126		10.500	.4134		15.600	.6142		<b>20.638</b>	<b>.8125</b>	<b>13/16</b>
0.400	.0157		5.500	.2165		10.600	.4173		15.700	.6181		20.700	.8150	
0.500	.0197		<b>5.556</b>	<b>.2188</b>	<b>7/32</b>	10.700	.4219		15.800	.6220		20.800	.8189	
0.600	.0236		5.600	.2205		<b>10.716</b>	<b>.4219</b>	<b>27/64</b>	<b>15.875</b>	<b>.6250</b>	<b>5/8</b>	20.900	.8228	
0.700	.0276		5.700	.2244		10.800	.4252		15.900	.6250		21.000	.8268	
<b>0.794</b>	<b>.0313</b>	<b>1/32</b>	5.800	.2283		10.900	.4291		16.000	.6299		<b>21.034</b>	<b>.8182</b>	<b>53/64</b>
0.800	.0315		5.900	.2323		11.000	.4331		16.100	.6339		21.100	.8307	
0.900	.0354		<b>5.953</b>	<b>.2344</b>	<b>15/64</b>	11.100	.4370		16.200	.6378		21.200	.8307	
1.000	.0394		6.000	.2362		<b>11.113</b>	<b>.4375</b>	<b>7/16</b>	<b>16.272</b>	<b>.6406</b>	<b>41/64</b>	21.200	.8346	
1.100	.0433		6.100	.2402		11.200	.4409		16.300	.6417		21.300	.8386	
<b>1.191</b>	<b>.0469</b>	<b>3/64</b>	6.200	.2441		11.300	.4449		16.400	.6457		21.400	.8425	
1.200	.0472		6.300	.2480		11.400	.4488		16.500	.6496		<b>21.431</b>	<b>.8438</b>	<b>27/32</b>
1.300	.0512		<b>6.350</b>	<b>.2500</b>	<b>1/4</b>	11.500	.4528		16.600	.6535		21.500	.8465	
1.400	.0551		6.400	.2520		<b>11.509</b>	<b>.4531</b>	<b>29/64</b>	<b>16.669</b>	<b>.6563</b>	<b>21/32</b>	21.600	.8504	
1.500	.0591		6.500	.2559		11.600	.4567		16.700	.6575		21.700	.8543	
<b>1.588</b>	<b>.0625</b>	<b>1/16</b>	6.600	.2598		11.700	.4606		16.800	.6614		21.800	.8583	
1.600	.0630		6.700	.2638		11.800	.4646		16.900	.6654		<b>21.828</b>	<b>.8594</b>	<b>55/94</b>
1.700	.0669		<b>6.747</b>	<b>.2656</b>	<b>17/64</b>	11.900	.4685		17.000	.6693		21.900	.8622	
1.800	.0709		6.800	.2677		<b>11.906</b>	<b>.4688</b>	<b>15/32</b>	<b>17.066</b>	<b>.6719</b>	<b>43/64</b>	22.000	.8661	
1.900	.0748		6.900	.2717		12.000	.4724		17.100	.6732		22.100	.8701	
<b>1.984</b>	<b>.0781</b>	<b>5/64</b>	7.000	.2756		12.100	.4764		17.200	.6772		22.200	.8740	
2.000	.0878		7.100	.2795		12.200	.4803		17.300	.6811		<b>22.225</b>	<b>.8750</b>	<b>7/8</b>
2.100	.0827		<b>7.144</b>	<b>.2813</b>	<b>9/32</b>	12.300	.4843		17.400	.6850		22.300	.8780	
2.200	.0866		7.200	.2835		<b>12.303</b>	<b>.4844</b>	<b>31/64</b>	<b>17.463</b>	<b>.6875</b>	<b>11/16</b>	22.400	.8819	
2.300	.0906		7.300	.2874		12.400	.4882		17.500	.6890		22.500	.8858	
<b>2.381</b>	<b>.0938</b>	<b>3/32</b>	7.400	.2913		12.500	.4921		17.600	.6929		22.600	.8898	
2.400	.0945		7.500	.2953		12.600	.4961		17.700	.6968		<b>22.622</b>	<b>.8906</b>	<b>57/64</b>
2.500	.0984		<b>7.541</b>	<b>.2969</b>	<b>19/64</b>	12.700	.5000	<b>1/2</b>	17.800	.7008		22.700	.8937	
2.600	.1024		7.600	.2992		12.800	.5039		<b>17.859</b>	<b>.7031</b>	<b>45/64</b>	22.800	.8976	
2.700	.1063		7.700	.3031		12.900	.5079		17.900	.7047		22.900	.9016	
<b>2.778</b>	<b>.1094</b>	<b>7/64</b>	7.800	.3071		13.000	.5118		18.000	.7087		23.000	.9055	
2.800	.1102		7.900	.3110		<b>13.097</b>	<b>.5156</b>	<b>33/64</b>	18.100	.7126		<b>23.019</b>	<b>.9063</b>	<b>29/32</b>
2.900	.1142		<b>7.938</b>	<b>.3125</b>	<b>5/16</b>	13.100	.5157		18.200	.7165		23.100	.9094	
3.000	.1181		8.000	.3150		13.200	.5197		<b>18.256</b>	<b>.7188</b>	<b>23/32</b>	23.200	.9134	
3.100	.1220		8.100	.3189		13.300	.5236		18.300	.7205		23.300	.9173	
<b>3.175</b>	<b>.1250</b>	<b>1/8</b>	8.200	.3228		13.400	.5276		18.400	.7244		23.400	.9213	
3.200	.1260		8.300	.3268		<b>13.494</b>	<b>.5313</b>	<b>17/32</b>	18.500	.7283		<b>23.416</b>	<b>.9219</b>	<b>59/64</b>
3.300	.1299		<b>8.334</b>	<b>.3281</b>	<b>21/64</b>	13.500	.5315		18.600	.7323		23.500	.9252	
3.400	.1339		8.400	.3307		13.600	.5354		<b>18.653</b>	<b>.7344</b>	<b>47/64</b>	23.600	.9291	
3.500	.1378		8.500	.3346		13.700	.5394		18.700	.7362		23.700	.9331	
<b>3.572</b>	<b>.1406</b>	<b>9/64</b>	8.600	.3386		13.800	.5433		18.800	.7402		23.800	.9370	
3.600	.1417		8.700	.3425		<b>13.891</b>	<b>.5469</b>	<b>35/64</b>	18.900	.7441		23.900	.9409	
3.700	.1457		<b>8.731</b>	<b>.3438</b>	<b>11/32</b>	13.900	.5472		19.000	.7480		24.000	.9449	
3.800	.1496		8.800	.3465		14.000	.5512		<b>19.050</b>	<b>.7500</b>	<b>3/4</b>	24.100	.9488	
3.900	.1535		8.900	.3504		14.100	.5551		19.100	.7520		24.200	.9528	
<b>3.969</b>	<b>.1563</b>	<b>5/32</b>	9.000	.3543		14.200	.5591		19.200	.7559		<b>24.209</b>	<b>.9531</b>	<b>61/64</b>
4.000	.1575		9.100	.3583		<b>14.288</b>	<b>.5625</b>	<b>9/16</b>	19.300	.7598		24.300	.9567	
4.100	.1624		<b>9.128</b>	<b>.3594</b>	<b>23/64</b>	14.300	.5630		19.400	.7638		24.400	.9606	
4.200	.1654		9.200	.3622		14.400	.5669		<b>19.447</b>	<b>.7656</b>	<b>49/64</b>	24.500	.9646	
4.300	.1693		9.300	.3661		14.500	.5709		19.500	.7677		24.600	.9685	
<b>4.366</b>	<b>.1719</b>	<b>11/64</b>	9.400	.3701		14.600	.5748		19.600	.7717		<b>24.606</b>	<b>.9688</b>	<b>31/32</b>
4.400	.732		9.500	.3740		<b>14.684</b>	<b>.5781</b>	<b>37/64</b>	19.700	.7756		24.700	.9724	
4.500	.1772		<b>9.525</b>	<b>.3750</b>	<b>3/8</b>	14.700	.5787		19.800	.7795		24.800	.9764	
4.600	.1811		9.700	.3819		14.800	.5827		<b>19.844</b>	<b>.7813</b>	<b>25/32</b>	24.900	.9803	
4.700	.1850		9.800	.3858		14.900	.5866		19.900	.7835		25.000	.9843	
<b>4.763</b>	<b>.1875</b>	<b>3/16</b>	9.900	.3898		15.000	.5906		20.000	.7874		<b>25.003</b>	<b>.9844</b>	<b>63/64</b>
4.800	.1890		<b>9.922</b>	<b>.3902</b>	<b>25/64</b>	<b>15.081</b>	<b>.5938</b>	<b>19/32</b>	20.100	.7913		25.100	.9882	
4.900	.1929		10.000	.3937		15.100	.5945		20.200	.7953		25.200	.9921	
5.000	.1969		10.100	.3976		15.200	.5984		<b>20.241</b>	<b>.7969</b>	<b>51/64</b>	25.300	.9961	
5.100	.2008		10.200	.4016		15.300	.6024		20.300	.7992		<b>25.400</b>	<b>1.000</b>	<b>1</b>

# Conversion Tables

Torque – Air Pressure – Miscellaneous

Torque Conversion Factors		
To Convert	Into	Multiply By
Inch Pounds	Foot Pounds	0.0835
Inch Pounds	Newton meters	0.1130
Inch Pounds	Kg-meters	0.0115
Inch Pounds	Kg-Cm	1.1519
Foot Pounds	Inch Pounds	12.000
Foot Pounds	Newton meters	1.3560
Foot Pounds	Kg-meters	0.1382
Foot Pounds	Kg-Cm	13.8240
Newton Meters	Inch Pounds	8.8440
Newton Meters	Foot Pounds	0.7370
Newton Meters	Kg-meters	0.1020
Newton Meters	Kg-Cm	10.2000
Kg meters	Inch Pounds	86.8100
Kg meters	Foot Pounds	7.2340
Kg meters	Newton-meters	9.8040
Kg Cm	Inch Pounds	0.8681
Kg Cm	Foot Pounds	0.0723
Kg Cm	Newton-meters	0.0980

Torque Conversion – In. Lbs. (Nm)					
In. Lbs.	Nm	In. Lbs.	Nm	In. Lbs.	Nm
5	0.6	50	5.7	140	15.8
10	1.1	60	6.8	150	17.0
15	1.7	70	7.9	160	18.1
20	2.3	80	9.0	170	19.2
25	2.8	90	10.2	180	20.3
30	3.4	100	11.3	190	21.5
35	4.0	110	12.4	200	22.6
40	4.5	120	13.6		
45	5.1	130	14.7		

Torque Conversion – Ft. Lbs. (Nm)							
Ft. Lbs.	Nm	Ft. Lbs.	Nm	Ft. Lbs.	Nm	Ft. Lbs.	Nm
1	1.36	33	44.8	65	88.1	97	131.5
2	2.7	34	46.1	66	90.0	98	133.0
3	4.1	35	47.5	67	90.9	99	134.2
4	5.4	36	48.8	68	92.2	100	135.6
5	6.8	37	50.2	69	93.6	110	149.2
6	8.1	38	52.0	70	94.9	115	156.0
7	9.5	39	52.9	71	96.3	120	163.0
8	10.9	40	54.2	72	97.6	125	170.0
9	12.2	41	55.6	73	99.0	130	176.3
10	13.6	42	57.0	74	100.3	135	183.1
11	14.9	43	58.3	75	102.0	140	190.0
12	16.3	44	60.0	76	103.1	145	197.0
13	17.6	45	61.0	77	104.4	150	203.4
14	19.0	46	62.4	78	105.8	155	210.2
15	20.3	47	63.7	79	107.1	160	217.0
16	21.7	48	65.1	80	108.5	165	224.0
17	23.1	49	66.4	81	110.0	170	231.0
18	24.4	50	67.8	82	111.2	175	237.3
19	25.8	51	69.2	83	112.6	180	244.1
20	27.1	52	70.5	84	114.0	185	251.0
21	28.5	53	71.9	85	115.3	190	258.0
22	29.8	54	73.2	86	117.0	195	264.4
23	31.2	55	74.6	87	118.0	200	271.2
24	32.5	56	75.9	88	119.3	225	305.1
25	33.9	57	77.3	89	121.0	250	339.0
26	35.3	58	78.7	90	122.0	275	373.0
27	36.6	59	80.0	91	123.4	300	407.0
28	38.0	60	81.4	92	125.0	350	475.0
29	39.3	61	82.7	93	126.1	400	542.4
30	40.7	62	84.1	94	127.5		
31	42.0	63	85.4	95	129.0		
32	43.4	64	86.8	96	130.2		

## Inch Bolt Torque Table

SAE J429 and ASME 574

Steel Grade	SAE 5		SAE 8		Socket Head Cap Screws	
	Torque in Pound Foot or (Pound Inch)					
Nom Dia - Pitch	Dry	Lubed	Dry	Lubed	Dry	Lubed
1/4-20	(101)	(76)	(143)	(107)	(168)	(120)
1/4-28	(116)	(87)	(147)	(123)	(192)	(144)
5/16-18	(209)	(157)	(295)	(221)	(348)	(264)
5/16-24	(231)	(174)	(327)	(245)	(384)	(288)
3/8-16	(372)	(276)	44	33	51	38
3/8-24	(420)	(312)	49	37	58	43
7/16-14	49	37	70	52	81	61
7/16-20	55	41	78	58	91	68
1/2-13	75	57	106	80	124	93
1/2-20	85	64	120	90	140	105
5/8-11	150	113	212	159	238	179
5/8-18	170	127	240	180	270	202
3/4-10	267	200	376	282	423	317
3/4-16	297	223	420	315	472	354
7/8-9	429	322	606	455	682	511
7/8-14	474	355	669	502	752	564
1-8	644	483	909	681	1022	767
1-12	722	542	1020	765	1147	860

## Metric Bolt Torque Table

ISO 898

Property Class	8.8		10.9		12.9 Socket Head Cap Screw	
	Torque in Newton Meter - Nm					
Nom Size x Pitch	Dry	Lubed	Dry	Lubed	Dry	Lubed
M5 x 0.80	6.1	4.6	8.8	6.7	10.3	7.7
M6 x 1.00	10.4	7.8	15	11.2	17.6	13.1
M7 x 1.00	17.6	13.1	25.1	18.9	29.4	22
M8 x 1.25	25.4	19.1	37.6	27.3	42.6	32.1
M10 x 1.50	50	38	72	54	84	64
M12 x 1.75	88	66	126	94	146	110
M14 x 2.00	141	106	201	150	235	176
M16 x 2.00	218	164	312	233	365	274
M18 x 2.50	301	226	431	323	504	378
M20 x 2.50	426	319	609	457	712	534
M22 x 2.50	580	435	831	624	971	728
M24 x 3.00	736	552	1052	789	1231	923
M27 x 3.00	1079	809	1544	1158	1805	1353
M30 x 3.50	1463	1097	2092	1570	2446	1834
M33 x 3.50	1990	1493	2849	2137	3328	2497
M36 x 4.00	2557	1918	3659	2744	4276	3208

Lubed means cleaned dry bolts lubricated with a standard medium viscosity machine oil. Lubricate all contact areas of the bolts and washers. Lubricating the bolts is the suggested method.

Miscellaneous Conversion Factors			Air Pressure Conversion		
To Convert	Into	Multiply By	PSI	kPa*	Bar**
Inches	Millimeters	25.4000	85	586	5.9
Millimeters	Inches	0.0394	90	620	6.2
Pounds	Kilograms	0.4536	95	655	6.6
Kilograms	Pounds	2.2050	100	690	6.9
psi	bar	0.069	125	860	8.6
bar	psi	14.5			

\*Preferred: Approximate to the nearest 5 kPa.  
\*\*Approximate to the nearest 0.5 Bar.

# Sales & Service Centers

Please note that all locations may not service all products. Please contact the nearest Apex Tool Group Sales & Service Center for the appropriate facility to handle your service requirements.

## DETROIT, MICHIGAN

**Apex Tool Group  
Sales & Service Center**  
2630 Superior Court  
Auburn Hills, MI 48326  
Tel: (248) 393 5640  
Fax: (248) 391 6295

## HOUSTON, TEXAS

**Apex Tool Group  
Sales & Service Center**  
6550 West Sam Houston  
Parkway North, Suite 200  
Houston, TX 77041  
Tel: (713) 849 2364  
Fax: (713) 849 2047

## SEATTLE, WASHINGTON

**Apex Tool Group  
Sales & Service Center**  
2865 152nd Ave N.E.  
Redmond, WA 98052  
Tel: (425) 497 0476  
Fax: (425) 497 0496

## LEXINGTON, SC

**Apex Tool Group**  
670 Industrial Drive  
Lexington, SC 29072  
Tel: (800) 845 5629  
Tel: (803) 951 7544  
Fax: (803) 358 7681

## LOS ANGELES, CALIFORNIA

**Apex Tool Group  
Sales & Service Center**  
6881 Stanton Avenue, Unit B  
Buena Park, CA 90621  
Tel: (714) 994-1491  
Fax: (714) 994-9576

## YORK, PENNSYLVANIA

**Apex Tool Group  
Sales & Service Center**  
York Service Center  
3990 E. Market Street  
York, PA 17402  
Tel: (717) 755 2933  
Fax: (717) 757 5063

## BRAZIL

**Apex Tool Group  
Sales & Service Center**  
Caixa Postal 692  
18001-970 Sorocaba, SP  
Brazil  
Tel: +55 15 2383929  
Fax: +55 15 2383260

## CANADA

**Apex Tool Group  
Sales & Service Center**  
5925 McLaughlin Road  
Mississauga, Ont. L5R 1B8  
Canada  
Tel: (905) 501 4785  
Fax: (905) 501 4786

## CHINA

Cooper (China) Co., Ltd.  
An Apex Tool Group, LLC company  
955 Sheng Li Road,  
Heqing Pudong, Shanghai  
China 201201  
Tel: +86 21 28994176  
Fax: +86 21 51118446

## ENGLAND

**Apex Tool Group  
GmbH & Co. OHG**  
C/O Spline Gauges  
Piccadilly, Tamworth,  
Staffordshire B78 2ER  
United Kingdom  
Tel: +44 1827 8741 28  
Fax: +44 1827 8741 28

## FRANCE

**Apex Tool Group SNC**  
25 rue Maurice Chevalier  
B. P. 28  
77831 Ozoir-la-Ferrière Cedex  
France  
Tel: +33 1 64 43 22 00  
Fax: +33 1 64 43 17 17

## GERMANY

**Apex Tool Group  
GmbH & Co. OHG**  
Industriestraße 1  
73463 Westhausen  
Germany  
Tel: +49 (0) 73 63 81 0  
Fax: +49 (0) 73 63 81 222  
E-mail: info@apexpowertools.eu

## HUNGARY

**Apex Tool Group  
Hungaria Kft.**  
Platánfa u. 2  
9027 Győr  
Hungary  
Tel: +36 96 66 1383  
Fax: +36 96 66 1135

## MEXICO

Cooper Tools  
de México S.A. de C.V.  
An Apex Tool Group, LLC company  
Vialidad El Pueblito #103  
Parque Industrial Querétaro  
Querétaro, QRO 76220  
Mexico  
Tel: +52 (442) 211 3800  
Fax: +52 (442) 103 0443

[www.apexpowertools.com](http://www.apexpowertools.com)

[www.apexpowertools.eu](http://www.apexpowertools.eu)

**One Of The Broadest Range Of Tools In The World Is At Your Fingertips!**

Apex Tool Group covers a wide range of industrial markets, including aerospace, automotive, foundries, furniture, general industry, metal fabrication, petroleum, power generation, shipbuilding, and transportation. These markets have been served by Apex Tool Group's brands for many decades, by offering our customers solutions and products that meet their demanding productivity requirements.

To receive a product catalog quickly, just go to [www.apextoolgroup.com](http://www.apextoolgroup.com). Select the literature you want. Then complete the "Contact Information" form, hit "Submit Request" and your order will be processed immediately. Materials normally arrive within 48 hours.

**Below are a few of our more popular power tools catalogs**



**Apex Fastener Tools**  
A comprehensive line of industrial quality bits, finders, sockets and extensions.  
(Catalog # TC-100)  
[www.apex-tools.com](http://www.apex-tools.com)



**Dotco/Cleco Material Removal Tools**  
A full line of pneumatic material removal tools including drills, sanders, and grinders.  
(Catalog # SP-102)  
[www.dotco-tools.com](http://www.dotco-tools.com)



**Master Power Industrial Air Tools**  
A complete line of industrial pneumatic tools for assembly and material removal applications.  
(Catalog # SP-904)  
[www.masterpowertools.com](http://www.masterpowertools.com)



**Apex Universal Joints**  
Industrial quality universal joints that can be custom designed for most any application.  
(Catalog # SP-1400)  
[www.apexuniversal.com](http://www.apexuniversal.com)



**DGD Assembly Systems**  
A complete line of spindles, D.C. electric assembly tools and controllers for the MVI.  
(Catalog # SP-703DE/EN)  
[www.apexpowertools.eu](http://www.apexpowertools.eu)



**Utica Torque Products**  
A full line of torque measuring products including torque screwdrivers, torque wrenches and analyzers.  
(Catalog # SP-301)  
[www.uticatools.com](http://www.uticatools.com)



**Cleco Pneumatic Assembly Tools**  
A full line of industrial pneumatic assembly tools from screwdrivers to nutrunners to impacts.  
(Catalog # SP-1000)  
[www.clecotools.com](http://www.clecotools.com)



**Cleco Power Motors**  
A comprehensive line of industrial pneumatic motors for a multitude of applications.  
(Catalog # SP-104)  
[www.clecotools.com](http://www.clecotools.com)



**Airetool Tube Cleaners & Expanders**  
A complete line of industrial tube cleaners, expanders and installation tools.  
(Catalog # SP-1100)  
[www.airetools.com](http://www.airetools.com)



**Cleco D.C. Electric Assembly Tools**  
A complete line of industrial D.C. electric assembly tools and controllers.  
(Catalog # SP-1020)  
[www.clecotools.com](http://www.clecotools.com)



## Warranty

---

Apex Tool Group, LLC warrants products and parts sold by it, insofar as they are of its own manufacture, against defects of material and workmanship, under normal use and service in accordance with its written instructions, recommendations, and ratings for installation, operation, maintenance, and service of products, for a period of **ONE YEAR FROM THE DATE OF INITIAL USE, BUT IN NO EVENT SHALL THE WARRANTY EXCEED 24 MONTHS FROM DATE OF DELIVERY TO DISTRIBUTOR.** Proof of Purchase with shipment date must be furnished by the user to validate the warranty. This warranty applies only to products manufactured by Apex Tool Group and specifically excludes products manufactured by others. Products not manufactured by Apex Tool Group are warranted only to the extent and in the manner warranted to Apex Tool Group by the manufacturer

and then only to the extent Apex Tool Group is able to enforce such warranty. Apex Tool Group's warranty with respect to products manufactured by it is limited to the repair or replacement, as Apex Tool Group may elect, of any defective part regarding which the Distributor has given 5 days written notice from the discovery of such defect. Installation and transportation costs are not included. Apex Tool Group shall have the option of requiring the return to it of the defective material, transportation prepaid, for inspection. No allowance will be made for repairs without Apex Tool Group approval. **APEX TOOL GROUP MAKES NO OTHER WARRANTY OF ANY KIND WHATSOEVER, EXPRESSED OR IMPLIED, AND HEREBY DISCLAIMS ALL WARRANTIES OF MERCHANTABILITY AND FITNESS FOR A PARTICULAR PURPOSE.**

## Lubrication Products

---

Apex Tool Group products are classified as non-hazardous manufactured items, defined in the OSHA 1910.1200 Hazard Communication Standard as "Articles". These products, under conditions of normal use, do not release or cause exposure to a hazardous chemical.

Under normal conditions of use, lubrication products sold separately for or used within these tools should not cause an exposure hazard. Refer to the Material Safety Data Sheet (M.S.D.S.) for Safety and Disposal Information. M.S.D.S. sheets are available upon request from Apex Tool Group.

Apex Tool Group is also aware of, and complies with, the provisions of section 611 amendments

to the Clean Air Act of 1990. No ozone depleting chemicals have been used in the manufacture of our products.

If you resell or distribute these products, you have the responsibility for ensuring that the Material Safety Data Sheets are provided to the purchaser.

Proper lubrication is essential to the economical operation of pneumatic and electric tools. Apex Tool Group perform better and their life is extended by using the recommended lubricants. All lubricants that are listed in the accessory section of this catalog have undergone extensive testing and are recommended for use with Apex Tool Group products.

## Fastener Selection

---

The suggested fasteners listed in this catalog are determined by matching a tool's maximum rated load to Society of Automotive Engineers (SAE) Grade 5 and International Organization of Standardization (ISO) Grade 9.8 fasteners. The torque capabilities for SAE Grade 5 fasteners are from SAE Manual, SAE J429 (Mechanical and Material Requirement for Externally Threaded Fasteners). The torque capabilities for ISO Grade 9.8 fasteners are from ISO 898-1 (Mechanical Properties of Fasteners). All values selected are based on lubricated fasteners.

The suggested fasteners listed in this catalog are advisory only, and Apex Tool Group recommends that you further consult other technical references before final tool selection. Reliance on the accuracy of this catalog data for any purpose by anyone is at the sole risk of that person. Apex Tool Group is not responsible for any loss, claim, or damage arising from improper tool selection.

The torque values listed under the headings "TORQUE" are tested on an ISO 5393 soft joint rate test fixture unless otherwise stated by a special note.

## General Safety Instructions

These Safety Instructions must be accessible to the operator at all times. They must be shown and made available to all people involved in the use of the tool.



The operator must understand the Safety Instructions and the Installation, Operation, and Adjustment Procedures provided in the Technical Manual (included with the tool). These Safety Instructions are not intended to be all inclusive. Study and comply with all applicable Federal, State, and Local Regulations. Contact your local distributor for assistance.



This symbol identifies the potential for a hazardous situation. If this warning is not followed, a serious injury could occur.



Always disconnect the tool from the air hose before adjusting or repairing.



Immediately shut off the tool in the case of unusual sound or vibration. Disconnect the tool from the air hose. Have a qualified person check the tool and repair before using.

When unpacking the tool, closely check for shipping damages and accuracy of the shipping documentation.



Do not wear loose clothing, jewelry, or rings. Injury may result from being caught in tools. Avoid direct contact with lubricants, grease or adhesives.



Safety glasses or face shield must be worn.



Wear gloves, ear protection and other protective equipment when required.

Do not modify the tool, any guard or accessory unless approved in writing by Apex Tool Group.

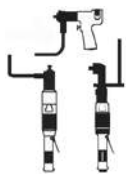

We recommend the use of a reaction bar to prevent an uncontrollable reaction of the tool. This use is dependant on the following factors: torque, joint, air pressure, form of the tool and the individual user. Consider the use of reaction bars to prevent possible injury.

Implement and follow a Safety Maintenance Program to provide inspection and maintenance of all phases of tool operation and air supply equipment.



Sockets and bits used with nutrunners and screwdrivers should be of the power tool or industrial type. Do not use hand tool sockets on a power tool. Hand tool sockets can break, resulting in a hazard of flying pieces. Worn sockets or bits reduce the power delivered to the fastener, cause drive wear and increase the chance for breakage. Inspect sockets, bits and drives for wear or damage and replace as necessary.

## Noise & Vibration

Refer to test data page included with tool.

## Intended Use

Air assembly tools are intended for tightening of threaded joints only. Tools must be used for their designated purpose. Do not use as a hammer, lever or other improper usage that can cause tool damage and lead to operator injury.

## Installation & Operation

Only qualified and trained operators should install, adjust or use air assembly tools.

Connect the tool to an air line with a maximum pressure of 6.2 bar (90 psig). Adjust the air line lubrication to a minimum to reduce possible contamination of the environment by the exhaust air. The work area must be well ventilated.



Inspect the air hose and fittings. Do not use damaged, frayed or deteriorated hoses. A hose rupture can cause injury.



When using right angle nutrunners, be sure the throttle is positioned relative to the angle head so the throttle will not become wedged against an adjacent object in the ON position due to torque reaction.

The angle head may be repositioned with respect to the lever to accommodate proper location for the task. If the tool is to be reversed, locate throttle lever in a neutral position that will prevent entrapment.

Keep the tool clean and dry to provide the best possible grip. The tool should be held in such a way to be safe and comfortable. Firmly grasp the handle of the tool and apply the socket to the joint before starting the tool.

## Adjusting Torque For Shut-Off Tools



Screwdrivers and nutrunners with clutches can stall rather than shut off if the clutch is adjusted over the maximum power output of the tool, or if there is a drop in the air pressure. Low or fluctuating air pressure can cause tool to fail to shut off! The user must be prepared to resist the torque until the throttle is released.

Expose clutch through movement of the clutch shield. Using the hex wrench supplied, turn clockwise for maximum torque or turn counterclockwise for minimum torque.

NOTE: For best results, start from "MIN" torque and adjust in "MAX" direction.

## Maintenance, Assembly & Disassembly

Inspect air assembly tools every 500 operating hours or every six months, whichever comes first. Replace worn parts using only genuine Apex Tool Group replacement parts.

# Model Number Index

Model	Page	Model	Page	Model	Page	Model	Page
200427	13,59	539317	53,63	867938	13	19PCA03Q	9
200428	13,59	540394	63	869168	13	19PCA04Q	9
200429	13,59	540397	63	869203	13	19PCA05Q	9
201012	36	542523	53	869204	13	19PCA06Q	9
201034	36	542892	39	869305	13	19PCA07Q	9
201039	36	550006	36	869306	13	19PCA09Q	9
201203	12	809451	12	869734	13	19PTA02Q	9
201510	36	809453	12	869770	36	19PTA03Q	9
201601	62	809470	12	928473	53	19PTA04Q	9
201606	62	809471	12	928474	53	19PTA05Q	9
201607	62	809473	12	928475	53	19PTA06Q	9
201608	62	809474	12	928477	53	19PTA07Q	9
201675	62	847245	12	928483	53	19PTA09Q	9
201690	62	847294	12	928485	53	19PTA15Q	9
201770	13	847299	12	928486	53	19PTS02Q	11
201898	36	847300	12	930119	53	19PTS03Q	11
201900	36,39	847301	12	931041	53	19PTS04Q	11
202346	13	847302	12	931663	53	19PTS05Q	11
202464	13	847303	12	931962	13	19RAA02AH2	19
202822	13	847304	12	932072	53	19RAA02AH3	19
202869	13	847305	12	934918	39,53	19RAA02AM2	19
202870	13	847480	12	935472	53	19RAA03AH2	19
203621	13	847481	12	935965	53	19RAA03AH3	19
203632	13	847482	12	935966	53	19RAA03AM2	19
203762	13	847483	12	939348	39	19RAA04AM2	19
203808	13	847484	12	46037036	36	19RAA05AM2	19
203833	13	847485	12	46037081	36	19RAA06AH2	19
204014	62	847486	12	46177030	36	19RAA06AH3	19
204119	62	847487	12	46437006	36	19RAA07AH2	19
204120	62	847488	12	46607016	36	19RAA07AH3	19
204122	62	849153	12	46607058	36	19RAA09AH2	19
204167	62	849154	12	48047128	36	19RAA09AH3	19
204987	36	849155	12	54397004	36	19RAA11AH2	19
205831	36	849156	12	110PHH55Q	52	19RAA11AH3	19
205833	36	849325	12	110PTHH30Q	51	19RAA12AH2	19
205834	36	849617	12	11PHH652	52	19RAA12AH3	19
205835	36	849618	12	11PHH653	52	19RAS03AM2	23
205837	36	849619	12	11PHH65Q	52	19RAS04AH2	23
205838	36	849620	12	11PTHH352	51	19RAS05AM2	23
205839	36	849621	12	11PTHH353	51	19RAS06AH3	23
207019	13	849843	12	11PTHH35Q	51	19SCA02B	7
207237	39	849879	12	120PHH554	52	19SCA02Q	7
207238	39	849891	12	120PTHH304	51	19SCA03B	7
301071	30	849892	12	140PH45Q	52	19SCA03Q	7
301072	30	849893	12	140PTHC25Q	51	19SCA04B	7
301081	36	849894	12	15STHC40Q	51	19SCA04Q	7
301106	13,36,39	849895	12	15STHFC40Q	51	19SCA05B	7
301108	36	849896	12	160PH456	52	19SCA05Q	7
412603	13	849897	12	160PTHC256	51	19SCA06B	7
513156	63	849898	12	19BPA02Q	7	19SCA06Q	7
521041	62	861006	13	19BPA03Q	7	19SPA02B	7
521042	62	863242	12	19BPA04Q	7	19SPA02Q	7
521060	62	865777	13	19BPA05Q	7	19SPA03B	7
533485	63	867711	36	19BPA06Q	7	19SPA03Q	7
536333	63	867931	13	19PCA02Q	9	19SPA04B	7

Model	Page	Model	Page	Model	Page	Model	Page
19SPA04Q	7	250PHF406	52	34RAS73F3	28	45-0732	63
19SPA05B	7	250PTHFC226	51	34RAS73H3	32	45-0734	63
19SPA05Q	7	2RSA-10B	7	34RCA30D1	30	45-0736	63
19SPA06B	7	2RSA-10SB	7	34RCA30D3	30	45-0742	63
19SPA06Q	7	301937PT	36,39	34RCS29D1	30	45-0744	63
19TCA02Q	9	302021PT	13,39	34RCS29D3	30	45-0745	63
19TCA03Q	9	34NRS29H15	43	35PHH653	52	45-0746	63
19TCA04Q	9	34NRS31H16	43	35PHH65Q	52	45-0747	63
19TCA05Q	9	34NRS35H20	43	35PTHH403	51	45-0748	63
19TCA06Q	9	34NRS36H15	43	35PTHH40Q	51	45-0753	63
19TCA07Q	9	34NRS36H18	43	35RSA-10-3	7	45-0918	63
19TCA09Q	9	34NRS38H16	43	35RSA-10Q	7	45-0919	63
19TTA02Q	9	34NRS42H25	43	35RSA-20Q	7	45-0980	63
19TTA03Q	9	34NRS46H18	43	35RSA-5-3	7	45-0983	63
19TTA04Q	9	34NRS46H20	43	35RSA-5Q	7	45-1307	63
19TTA05Q	9	34NRS48H29	43	35RSA-7Q	7	45-1408	63
19TTA06Q	9	34NRS52H25	43	35RSAP-10Q	10	45-1409	63
19TTA07Q	9	34NRS53H37	43	35RSAP-7Q	10	45-1508	63
19TTA09Q	9	34NRS63H29	43	35RSAPT-5Q	10	45-1610	63
19TTA15Q	9	34NRS68H37	43	35RSAPT-7Q	10	45-1810	63
19TTS02Q	11	34RAA08AL3	19	35RSATP-10-3	10	45-1812	63
19TTS03Q	11	34RAA09F1	28	35RSATP-10Q	10	45-1825	63
19TTS04Q	11	34RAA11AL3	19	35RSATP-20Q	10	45-1982	63
19TTS05Q	11	34RAA15AM3	19	35RSATP-5-3	10	45NAB-3P-4	21
207596PT	13	34RAA16F1	28	35RSATP-5Q	10	45RNAB-2-4	27
207652PT	13	34RAA26AH3	19	35RSATP-7Q	10	45RNAB-2P-4	21
207696PT	13	34RAA28AH3	19	35STHFA404	51	45RNAB-2T-4	21
20PHH753	52	34RAA28F1	28	35STHFA40Q	51	45RNAB-3-3	27
20PHH75Q	52	34RAA33AX3	19	35STHFC404	51	45RNAB-3P-4	21
20PTHH403	51	34RAA33F2	28	35STHFC40Q	51	45RNAB-3T-4	21
20PTHH40Q	51	34RAA37AX3	19	400PHF356	52	45RNAB-4-3	27
24NRS15A12	43	34RAA47AX3	19	400PTHFC206	51	45RNAB-4T-4	21
24NRS15A13	43	34RAA47F2	28	41NDR130H15	44	45RNAB-6-3	27
24NRS20H15	43	34RAA53F2	28	41NDR130H16	44	45RNB-2T-4	23
24NRS21H16	43	34RAA53H3	32	41NDR130H18	44	45RNB-3P-4	23
24NRS23A13	43	34RAA67F3	28	41NDR130H20	44	45RNB-3T-4	23
24NRS23H15	43	34RAA67H3	32	41NDR130H25	44	45RNB-4T-4	23
24NRS23H20	43	34RAA68AZ3	19	41NDR172H15	44	541715-5	36
24NRS24A12	43	34RAA68AZ4	19	41NDR172H16	44	55NAL-2T-4	21
24NRS24H16	43	34RAA75AZ3	19	41NDR172H20	44	55NAL-3P-4	21
24NRS24H18	43	34RAA75AZ4	19	41NDR172H25	44	55NAL-3T-4	21
24NRS29H18	43	34RAA94F3	28	41NDR236H15	44	55NAL-4P-4	21
24NRS29H25	43	34RAA94H3	32	41NDR236H16	44	55NAL-4T-4	21
24NRS30H20	43	34RAS103F3	28	41NDR236H18	44	55NL-2T-4	23
24RAA06AL3	19	34RAS103H3	32	45-0710	63	55NL-3T-4	23
24RAA07AL3	19	34RAS10F1	28	45-0711	63	55PHH603	52
24RAA11AL3	19	34RAS11AL3	23	45-0712	63	55PTHH403	51
24RAA12AM3	19	34RAS18F1	28	45-0713	63	55RNAL-2-4	27
24RAA19AM3	19	34RAS28AH3	23	45-0717	63	55RNAL-2T-4	21
24RAA23AM3	19	34RAS30F1	28	45-0720	63	55RNAL-3-4	27
24RAS13AM3	23	34RAS36AX3	23	45-0722	63	55RNAL-3P-4	21
24RTA12	34	34RAS40F2	28	45-0724	63	55RNAL-3T-4	21
24RTA20T2	34	34RAS52F2	28	45-0725	63	55RNAL-4-4	27
24RTA30T3	34	34RAS58F3	28	45-0726	63	55RNAL-4P-4	21
24RTA40T4	34	34RAS58H3	32	45-0727	63	55RNAL-4T-4	21

Model	Page	Model	Page	Model	Page	Model	Page
55RNAL-6T-4	21	75NAL-2V-4	21	937445PT	53	SBA-12	61
55RNL-2T-4	23	75NL-2V-4	23	937446PT	53	SBA-12-AH	61
55RNL-3T-4	23	75NL-2X-6	23	937446PT	53	SBA-18	61
55RNL-7T-4	23	75NL-3V-4	23	937447PT	53	SBA-18-AH	61
60NDR092HD24	44	75RNAL-2V-4	21	937447PT	53	SBA-24-AH	61
60NDR092HD40	44	75RNAL-2X-6	21	937448PT	53	SBA-30-AH	61
60NDR092HD48	44	75RNAL-3V-4	21	937448PT	53	SBA-30-WM	61
60NDR092HD56	44	75RNAL-3X-6	21	937449PT	53	SW-102	63
64TTK110D4	27	75RNL-2X-6	23	937449PT	53	SW-103	63
64TTK125D4	27	75RNL-3V-4	23	937450PT	53	SW-104	63
64TTK1260D8	27	75RNL-3X-6	23	937450PT	53	SWR-102	63
64TTK140D4	27	7PHH602	52	937451PT	53	TVP-110-15-D	38
64TTK1475D8	27	7PHH60Q	52	937451PT	53	TVP-110-15-P	38
64TTK150D6	27	7PTHH352	51	A139856	63	TVP-110-15-S	38
64TTK175D6	27	7PTHH35Q	51	BL-2A	13,59	TVP-110-15-U	38
64TTK1820D8	27	7STHFA55Q	51	BL-4A	13,59	TVP-110-30-D	38
64TTK1985D8	27	7STHFC55Q	51	BL-6A	59	TVP-110-30-P	38
64TTK205D6	27	80PHH604	52	BL-8A	59	TVP-110-30-S	38
64TTK255D6	27	80PHH60Q	52	BLL-6A	59	TVP-110-30-U	38
64TTK345D6	27	80PTHH354	51	BLL-8A	59	W-2109-8	57
64TTK34D4	27	80PTHH35Q	51	BM-13A	59	W-2120-12	57
64TTK3850D12	27	88RSA-5C-3	7	BM-18A	59	WL-200-3	57
64TTK425D6	27	88RSA-5CQ	7	BM-25A	59	WL-200-4	57
64TTK44D4	27	88RSA-7C-3	7	BM-35A	59	WP-2049-6	57
64TTK55D4	27	88RSA-7CQ	7	BM-45A	59	WP-2050-6	57
64TTK570D6	27	88RSAL-5C-3	7	BML-13A	59	WP-2059-6	57
64TTK640D8	27	88RSAL-5CQ	7	CPBA-12-AH	61	WP-2059-8	57
64TTK750D8	27	88RSAPT-2CQ	10	CPBA-18	61	WP-2059-8-6E	57
64TTK75D4	27	88RSAPT-5C-3	10	CPBA-18-AH	61	WP-2060B-6	57
64TTK90D4	27	88RSAPT-5CQ	10	CPBA-30	61	WP-2060B-8	57
64TTK930D8	27	88RSAPT-7CQ	10	CPBA-30-AH	61	WP-2109B-8	57
64TTS110D4	27	88RSATP-2C-3	10	CPBA-30-WM	61	WP-2110B-8	57
64TTS125D4	27	88RSATP-2CQ	10	CSBA-12-AH	61	WP-255-3P	57
64TTS1260D8	27	88RSATP-5C-3	10	CSBA-18-AH	61	WP-455-4P	57
64TTS140D4	27	88RSATP-5CQ	10	CSBA-24	61	WP-455-4R	57
64TTS1475D8	27	88RSATP-7C-3	10	CSBA-30	61	WPS-2109B	57
64TTS150D6	27	88RSATP-7CQ	10	CSBA-30-AH	61	WS-2119	57
64TTS175D6	27	88SA-5C-3	7	CSBA18	61	WT-2109-8	57
64TTS1820D8	27	88SA-5CQ	7	H16NDR09H15	44	WT-2110-8	57
64TTS1985D8	27	88SA-7CQ	7	H16NDR09H20	44	WT-2119-12	57
64TTS205D6	27	8RNP-10BQ	11	H30NDR08H15	44	WT-2120-12	57
64TTS255D6	27	8RNP-20BQ	11	H30NDR08H16	44	WTS-2109	57
64TTS345D6	27	8RSA-10	7	H30NDR08H18	44	WTS-2119	57
64TTS34D4	27	8RSA-10BQ	7	H30NDR08H20	44	WTS-2120	57
64TTS3850D12	27	8RSA-5BQ	7	H30NDR08H25	44		
64TTS425D6	27	8RSA-7BQ	7	PBA-12	61		
64TTS44D4	27	8RSAL-10BQ	7	PBA-12-AH	61		
64TTS55D4	27	936695PT	53	PBA-12-WM	61		
64TTS570D6	27	937442PT	53	PBA-18	61		
64TTS640D8	27	937442PT	53	PBA-18-18-AH	61		
64TTS750D8	27	937443PT	53	PBA-18-AH	61		
64TTS75D4	27	937443PT	53	PBA-24	61		
64TTS90D4	27	937444PT	53	PBA-24-AH	61		
64TTS930D8	27	937444PT	53	PBA-30-AH	61		
75 NAL-2X-6	21	937445PT	53	PL-12A	13,59		

## Power Tools Sales & Service Centers

Please note that all locations may not service all products. Please contact the nearest Apex Tool Group Sales & Service Center for the appropriate facility to handle your service requirements.

### DETROIT, MICHIGAN

**Apex Tool Group  
Sales & Service Center**  
2630 Superior Court  
Auburn Hills, MI 48326  
Tel: (248) 393 5640  
Fax: (248) 391 6295

### HOUSTON, TEXAS

**Apex Tool Group  
Sales & Service Center**  
6550 West Sam Houston  
Parkway North, Suite 200  
Houston, TX 77041  
Tel: (713) 849 2364  
Fax: (713) 849 2047

### SEATTLE, WASHINGTON

**Apex Tool Group  
Sales & Service Center**  
2865 152nd Ave N.E.  
Redmond, WA 98052  
Tel: (425) 497 0476  
Fax: (425) 497 0496

### LEXINGTON, SC

**Apex Tool Group**  
670 Industrial Drive  
Lexington, SC 29072  
Tel: (800) 845 5629  
Tel: (803) 951 7544  
Fax: (803) 358 7681

### LOS ANGELES, CALIFORNIA

**Apex Tool Group  
Sales & Service Center**  
6881 Stanton Avenue, Unit B  
Buena Park, CA 90621  
Tel: (714) 994-1491  
Fax: (714) 994-9576

### YORK, PENNSYLVANIA

**Apex Tool Group  
Sales & Service Center**  
York Service Center  
3990 E. Market Street  
York, PA 17402  
Tel: (717) 755 2933  
Fax: (717) 757 5063

### BRAZIL

**Apex Tool Group  
Sales & Service Center**  
Caixa Postal 692  
18001-970 Sorocaba, SP  
Brazil  
Tel: +55 15 2383929  
Fax: +55 15 2383260

### CANADA

**Apex Tool Group  
Sales & Service Center**  
5925 McLaughlin Road  
Mississauga, Ont. L5R 1B8  
Canada  
Tel: (905) 501 4785  
Fax: (905) 501 4786

### CHINA

Cooper (China) Co., Ltd.  
An Apex Tool Group, LLC company  
955 Sheng Li Road,  
Heqing Pudong, Shanghai  
China 201201  
Tel: +86 21 28994176  
Fax: +86 21 51118446

### ENGLAND

**Apex Tool Group  
GmbH & Co. OHG**  
C/O Spline Gauges  
Piccadilly, Tamworth,  
Staffordshire B78 2ER  
United Kingdom  
Tel: +44 1827 8741 28  
Fax: +44 1827 8741 28

### FRANCE

**Apex Tool Group SNC**  
25 rue Maurice Chevalier  
B. P. 28  
77831 Ozoir-la-Ferrière Cedex  
France  
Tel: +33 1 64 43 22 00  
Fax: +33 1 64 43 17 17

### GERMANY

**Apex Tool Group  
GmbH & Co. OHG**  
Industriestraße 1  
73463 Westhausen  
Germany  
Tel: +49 (0) 73 63 81 0  
Fax: +49 (0) 73 63 81 222  
E-mail: info@apexpowertools.eu

### HUNGARY

**Apex Tool Group  
Hungaria Kft.**  
Platánfa u. 2  
9027 Győr  
Hungary  
Tel: +36 96 66 1383  
Fax: +36 96 66 1135

### MEXICO

Cooper Tools  
de México S.A. de C.V.  
An Apex Tool Group, LLC company  
Vialidad El Pueblito #103  
Parque Industrial Querétaro  
Querétaro, QRO 76220  
Mexico  
Tel: +52 (442) 211 3800  
Fax: +52 (442) 103 0443

[www.apexpowertools.com](http://www.apexpowertools.com)

[www.apexpowertools.eu](http://www.apexpowertools.eu)



**Kompania Narzędziowa "HERMES" Sp. z o.o.**  
ul. Sarni Stok 73 a, 43-300 Bielsko-Biała, Polska; tel: +48 33 821 41 90-91  
e-mail: [biuro@hermestools.eu](mailto:biuro@hermestools.eu) [www.hermestools.eu](http://www.hermestools.eu)

Apex Tool Group, LLC  
1000 Lufkin Road  
Apex, NC 27539  
Phone: 919-387-0099  
Fax: 919-387-2614  
[www.clecotools.com](http://www.clecotools.com)

**Cleco®**